

EN220700602

HYDMARK APPLICON

A 5/4& 6/4, PHASE II, INDUSTRIAL AREA, MAYAPURI
NEW DELHI - 110064
PHONE: +91-11-45114611-30 lines, FAX: +91-11-28116246
E-mail: sales@hydmark.com

QUOTATION

OUR REF. HAQ/JAL/22-23/537

DATE 23.07.2022

M/s. Jindal Aluminium Ltd.,
Bhiwadi division,
SP-2/333, Industrial area, Bhiwadi-301019
Alwar Distt., (Rajasthan)

YOUR REF.: - Your Enquiry no. EN220700602,
22.07.2022

Kind Attn.: - Rajgopal. C. Sarda
(Asst. Manager Purchase)

Tel.: 080- 27735051/ 52 Mob. 9611195368

Email: rajgopal@jindalaluminium.com

Dear Sir,
We feel pleasure in forwarding our quotation for the following:

S. NO.	DESCRIPTION	QTY.	UNIT PRICE
1.	<u>LOCKING RING OF CONTAINER FOR BP3 PRESS</u> ❖ As per your drawing no. : BP3-1100-19-A3 ❖ Material – EN8 ❖ Part No. 1	01 No.	@ ₹ 43,700.00 Each (@ Rupees forty three thousand seven hundred only)
2.	<u>LOCKING RING OF CONTAINER FOR BP3 PRESS</u> ❖ As per your drawing no. : BP3-1100-19-A3 ❖ Material – EN8 ❖ Part No. 2	01 No.	@ ₹ 43,700.00 Each (@ Rupees forty three thousand seven hundred only)
3.	<u>PISTON RODS FOR BP4 CONTAINER SHIFTING CYLINDER</u> ❖ As per your drawing no. : BP4-2100-21-A3 ❖ Material – C45 ❖ Part No. 1	02 Nos.	@ ₹ 1,15,800.00 Each (@ Rupees one lac fifteen thousand eight hundred only)
4.	<u>CONTAINER HOLDER LOCK NUTS</u> ❖ As per your drawing no. : BP4-2100-21-A3 ❖ Material – EN24 ❖ Part No. 2	02 Nos.	@ ₹ 13,800.00 Each (@ Rupees thirteen thousand eight hundred only)

Our terms & conditions of business are as per the details listed below:

CHECK LIST	
Payment Terms	Within 30 days
Price Basis	Ex - Bhiwadi.
GST	18% Extra /As applicable
Our GST No.	07AAAPO2514K1ZV
HSN Code	84129090
Delivery	6 - 8 Weeks after the firm placement of order with drawing approval
Packing & Forwarding	Nil
Freight	Nil
Validity of quotation	15 days.

We shall look forward to receipt of your valuable order.

Thanking you,
Yours Sincerely,

A.P.S. Oberoi

Enclosures:

S. No.	Description	Page
	30 days	
	FOR - JAL Bhiwadi	
	Nil	

Discussed with
Mr. Oberoi &
agreed above
10/08/22

06 weeks



Dated : 23.07.2022

M/s Jindal Aluminium Limited
SP-2/333, Industrial Area
Bhiwadi Dist., Alwar
Rajasthan - 301 019

Dear Sir,

S.No.	Item Description	Drawing No.	UOM	Quantity	Price	Total
1	Container Lock Ring for BP3 Press	BP3-1100-19-A3, Part No.1	Nos.	1	33,000.00	33,000.00
2	Container Holder Lock Nut	BP4-2100-21-A3, Part No.2	Nos.	2	33,000.00	66,000.00
3	Piston Rod	BP4-2100-21-A3	Nos.	2	102,302.00	204,604.00
4	Container Lock Ring	BP3-1100-19-A3, Part No.2	Nos.	1	33,000.00	33,000.00
5	RAM FOR P-1 BUTT SHEAR	BP1-1650-31-A3	Nos.	1	140,227.00	140,227.00
		Total		7	341,529.00	476,831.00
6	GST 18%					85,829.00
		Total				562,660.00

Final Rates
Rs. 29700/-
Rs. 29700/-
Rs. 92000/-
Rs. 29700/-

Payment Terms : 50% Advance and 50% against Performa.
Handling Charges - 5%.
Freight - As actual.

Thanking You,

For Micro Hydrotechnic Pvt. Ltd.

Charanjit
(Charanjeet Kaur)
Sales

Discussed with Mr. Sumit and agreed above rates

CHECK LIST

DISCOUNT *Rate as above*

EXTRA *Inc*

EXTRA *N.A*

EXTRA *IGST: 18% Bawal*

TERM: *30 days Credit*

FOR *JAL BND*

06 weeks

Micro Hydrotechnic Pvt. Ltd.

Regd. Office : Micro House B-93 , Maya Puri Industrial Area
Phase - 1 Opp T&T Motors (Mercedes) New Delhi-110064
Works : Plot No.223 & 224, Sector-9, Phase-III, Industrial Growth Centre, IMT Bawal,
Rewari, Haryana-123501
CIN : U29199DL2003PTC122301
Mobile : 9350230826, 9717474831
Landline : 011-40644399
Email : sales@microhydrotechnic.co.in, vartika.mahajan@microhydrotechnic.co.in
GSTIN No. Delhi : 07AADCM9466C1ZD
GSTIN No. Bawal : 06AADCM9466C1ZF
Website : www.microhydraulicpress.com

S.N.D. INDUSTRIES

3/A Sri Skanda Nilayam, Abbigere main road, 4th Cross, Near Sujatha
Wood Industries, K.G.Halli, Jalahalli West, Bangalore-560015
Email: sndindustries2011@gmail.com Mob: - 09036635315

TO,

EN no: EN210701036

Date: 233/07/21

QTN: 2367

JINDAL ALUMINIUM LIMITED
Jindal Nagar, 16 km,
Tumkur Road
Bangalore 560 073

Sub: Quotation for manufacturing

Sln0	Item	Qty	Rate/-	Amount
1	CONTAINER HOLDER LOCK NUT AS PER DRG. NO.BP4-2100-21-A3, PART NO.-2,,	02nos	5650/-	11300.00
2	CONTAINER LOCK RING FOR BP3 PRESS AS PER DRG. NO.BP3-1100-19-A3, PART NO.-2,,	01nos	14750/-	14750.00
3	CONTAINER LOCK RING FOR BP3 PRESS AS PER DRG. NO.BP3-1100-19-A3, PART NO.-1,,	01nos	14750/-	14750.00
4	PISTON ROD FOR BP4 CONTAINER SHIFTING CYLINDER AS PER DRG. NO.- BP4-2100-21-A3, PART NO.-1,,	02nos	64250/-	128500.00

Final Rate

Rs. 5425

Rs. 14310

Rs. 14310

Rs. 62322

1. Including of transport to Jindal Alu
2. Delivery term approximant 4 Week
3. Payment term 1 Week from date of invoice

CHECK LIST

DISCOUNT Rate as per
For: S.N.D. Industries
(Dinakar)
Proprietor

Discussed with
Mr. Dinakar and
agreed above rate.
10/08/22

30 days Credit.
FOR - JAL BWP
4 to 5 weeks



INDRO INDUSTRIES



AN ISO 9001: 2008 CERTIFIED COMPANY

ENGINEERS, MANUFACTURER & FABRICATORS

13/6, NATABAR PAUL ROAD (KADAMTALA) HOWRAH – 711 101. WEST BENGAL

TEL.NO.033-2643-8105, E.MAIL:indroindustries@yahoo.co.in Website: www.indroindustries.com

QUOTATION

QUOTATION NO-II/Q/300/2022-23
REF ENQ. NO. EN220700602

DATE 09.08.2022
DATE 09.08.2022

TO,
M/S. JINDAL ALUMINIUM LIMITED
BHIWADI.

Dear Sir

Thanking you for your above enquiry and we are pleased to submit our lowest best offer. Our terms & conditions are given below.

SL.NO.	Item Code.	Materials Description	Quantity	Prices	Per
1.	06641839	PISTON ROD FOR BP4 CONTAINER SHIFTING CYLINDER AS PER DRG. NO.- BP4-2100-21-A3, PART NO.-1	02 NOS.	40,000/-	EACH
2.	06641842	CONTAINER LOCK RING FOR BP3 PRESS AS PER DRG. NO.BP3-1100-19-A3, PART NO.-2	01 NOS.	7,100/-	EACH
3.	06641840	CONTAINER HOLDER LOCK NUT AS PER DRG. NO.- BP4-2100-21-A3, PART NO.-2	02 NOS.	4,000/-	EACH
4.	06641841	CONTAINER LOCK RING FOR BP3 PRESS AS PER DRG.NO.BP3-1100-19-A3, PART NO.-1	01 NOS.	7,100/-	EACH

Final Rate

Rs. 3800/- Each
Rs. 6750/- Each
Rs. 3800/- Each
Rs. 6750/- Each

We trust our offer will be acceptable to you and will be favored with your valued order.

TERMS & CONDITIONS.

- SALES TAX : G.S.T. 18% WILL BE CHARGE EXTRA
- TRANSPORTATION : DOOR DELIVERY BASIS.
- PAYMENT : WITH IN 30 DAYS.
- DELIVERY : WITHIN 8-10 WEEKS
- INSPECTION : AT YOUR WORKS
- VALIDITY : 30 DAYS

Discussed with Mr. Susanta and agreed above order.

OUR G.S.T. NO. 19AAFFI1702C1ZX

10/08/22

CHECK LIST	
DISCOUNT	<i>Rate as above</i>
PDF : INCLUDED	<i>Incl</i>
ED : INCLUDED	<i>N.A.</i>
CGST/UTVAT	<i>IGST: 18% Extra</i>
PAYMENT TERM	<i>30 days Credit</i>
FOR BENGALURU	<i>FOR JAL BWP</i>
VALIDITY	<i>6 weeks</i>

[ARUP KUMAR BANERJEE]
SALES EXECUTIVE
MOBILE NO. 09339288975

(To will be provided)

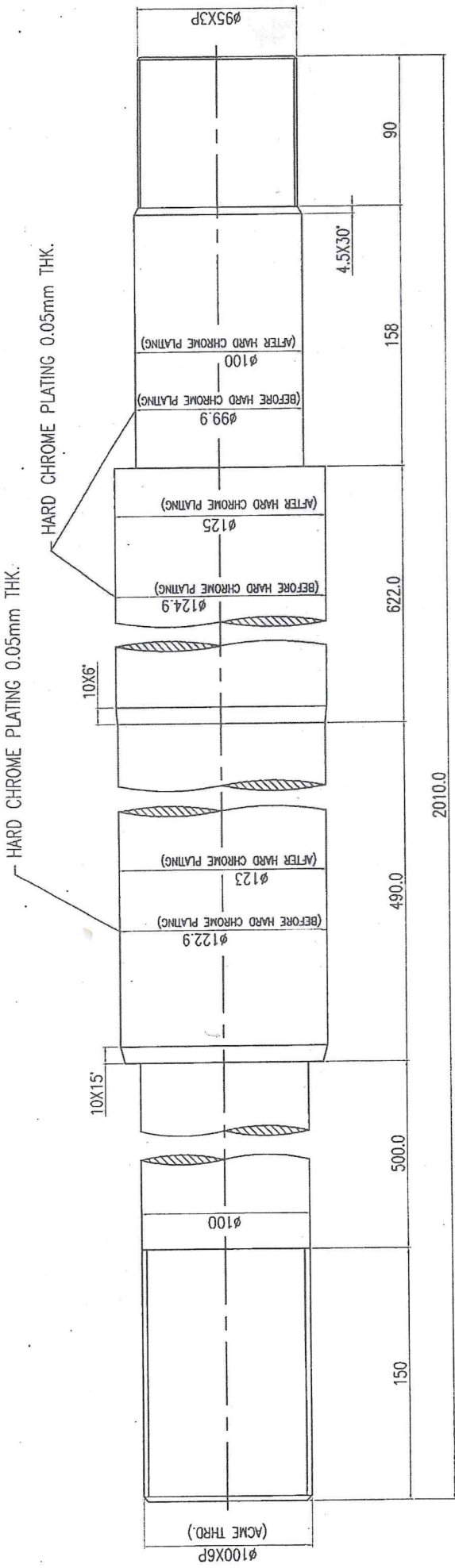

PISTON ROD
 MATERIAL:-C-45
 PART NO-1

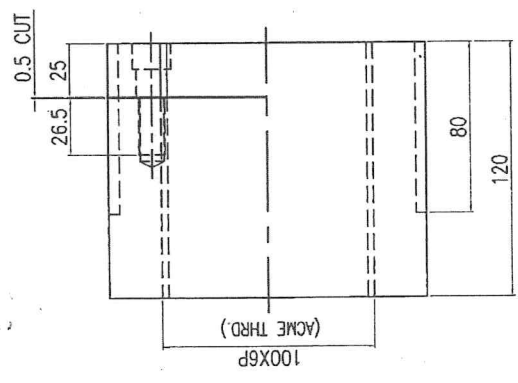

CONTAINER LOCKING NUT
 MATERIAL:-EN24
 PART NO-2

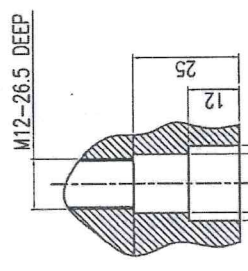
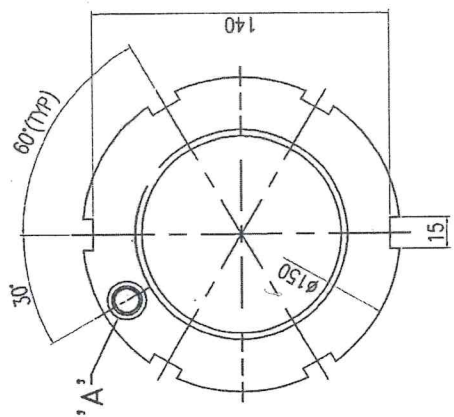

VIEW-'A'
 SCALE:-2:1

OK
 18/07/22

JINDAL ALUMINIUM LTD.		NAME	DATE
SP-2/393, INDUSTRIAL AREA, BHIWADI, RAJASTHAN-301019		VIKAS	18.07.22
ALL DIMENSIONS ARE IN mm., UNLESS OTHERWISE SPECIFIED		DRN.	18.7.22
SCALE 1:1		CKD.	18/07/22
PISTON ROD WITH CONTAINER LOCKING NUT FOR CONTAINER CYLINDER BP4 PRESS)		APPD.	18/07/22
DRAWING NO.		BP4-2100-21-A3	

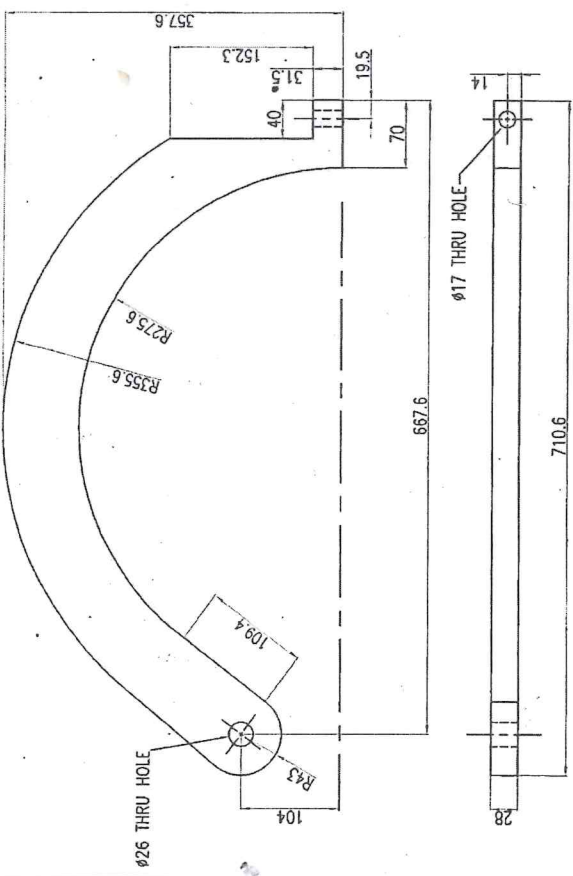

PART NO-1
QTY.-1 NOS

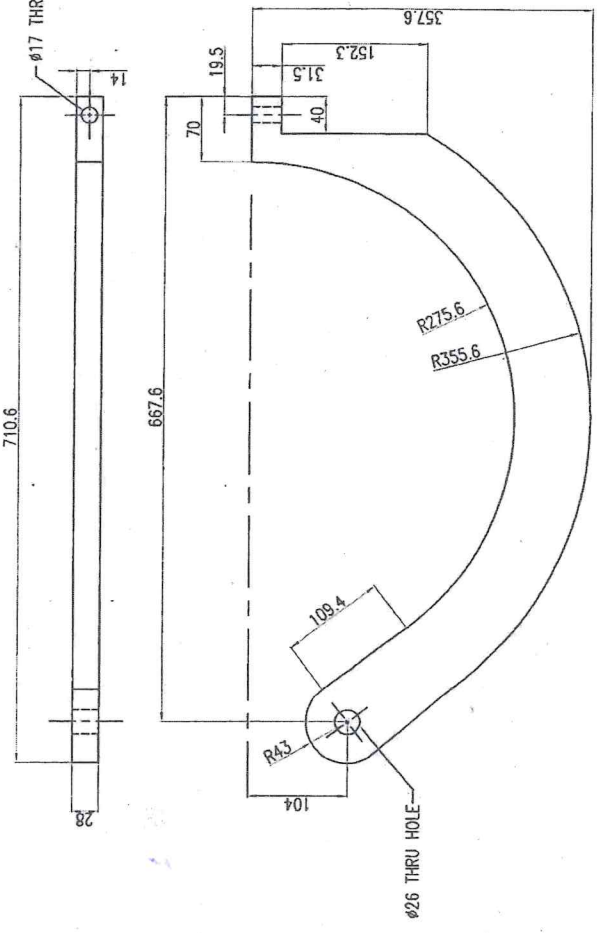

PART NO-2
QTY.-1 NOS

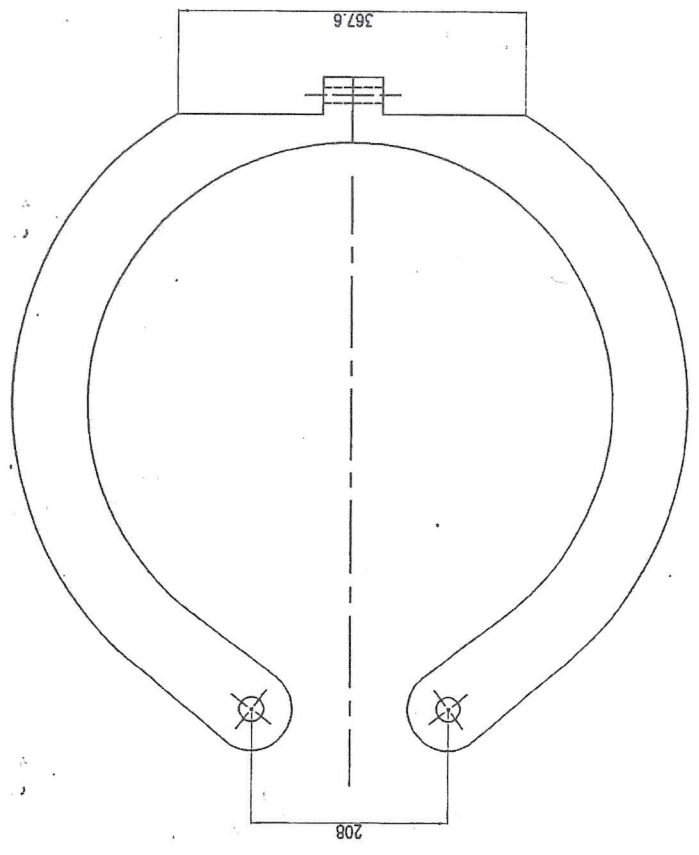

Handwritten signature and date: 18/07/22

MATERIAL:-EN8

JINDAL ALUMINIUM LTD. SP-2/333, INDUSTRIAL AREA, BHIWADI, RAJASTHAN-301019		DRN. VIKAS	DATE 18.07.22
ALL DIMENSIONS ARE IN mm., UNLESS OTHERWISE SPECIFIED		CKD. <i>[Signature]</i>	18.2.22
SCALE 1:1	LOCKING RING OF CONTAINER FOR BP3 PRESS	APPD. <i>[Signature]</i>	19/07/22
DRAWING NO. BP3-1100-19-A3			

