



Indian Global Sourcing Industries

Factory at J-1265 C Industrial Area Phase-V Bhiwadi Rajasthan India
GSTIN-08BNWPS3197L125
mail at- vipin@indianglobal.co.in, saurabh.srivastava@indiantrading.in
Mobile-+91 7268087854, 9811600164

QUOTATION

To:		Quotation No.	2223082
M/s	Jindal aluminium LTD Bhiwadi	Date	05.12.22
EN220800721		Contact Person	Mr Vipin Tiwari
		Contact No	+91 7268087854
		ENQUIRY NO	EN22080073

Kind Attn: Mr. Rajgopal
Sir,
We are pleased to quote our lowest possible rate for your perusal & consideration

Sr. No.	JAL MATERIAL CODE	Particulars	HSN Code	Price/Nos	MOQ/Nos	Net Rate
1	6981122	LOG CLAMP BRACKET FOR BP1 HOT LOG SHEAR AS PER DRG.NO.-HLS-BP1-13-A3, PART NO.-2,	8207	42500	2400	42500
2	✓ 6400575	SEMI FINISHED LINER FOR BP1 PRESS CONTAINER DIA168 BP1-1650-05-A3-R1	8207	450000	3	450000
3	6090217	ASSEMBLY OF FIXED TYPE DUMMY BLOCK FOR BP1 PRESS AS PER DRG.NO.BP1-1650-32-A1,	8207	89500	3	89500
4	✓ 6640007	SOLID STEM FOR BP-1 PRESS AS PER DRG.NO.BP1-1650-33-A3,	8207	480000	3	480000
5	6981121	BILLET CLAMP BRACKET FOR BP1 HOT LOG SHEAR AS PER DRG.NO.-HLS-BP1-13-A3, PART NO.-1,,	8207	42500	2400	42500
6	6920275	HOT LOG SHEAR RING (CUTTER) FOR BP1 PRESS AS PER DRG.NO.-HLS-BP1-17-A3 (LOG DIA 161MM),	8207	95000	2	95000
Gross Total						1964800

Terms Of Delivery	All Tax Extra As Applicable
Tax-Validity	15-days
Inspection	As Per Requirement
Transport	As Actual
Delivery-	5-10Week
Payment:-	70% ADVANCE BALANCE 15 DAYS

1- Material use Hitachi or Bower	Authorized Sign
2-	<i>Saurabh Srivastava</i>
3-	
4-	

Called, discussed in detail with each and every client and get the consistency all the inputs finally putty of each the above rates.

*(Signature)
13/01/23*

CHECK LIST

DISCOUNT *of Rate as above*

PRICE BASIS : FOR BHIWADI *FOR-JAL BWP.*

T & F : INCL / EXTRA

GST/TGST : *18% Extra*

DELIVERY : *2 weeks*

PAYMENT : *Approx 295000*

GCM/CIC : *HP-13 Imported steel*

VALIDITY : *metal require/BOL has considered and will be provided by party*

CHECKED BY : *Rajgopal*

77 advance 60% and rest 15 days after receipt of material

Indent No. → DI220701675 Urgent

HYDMARK APPLICON		QUOTATION	
A 5/4 & 6/4, PHASE II, INDUSTRIAL AREA, MAYAPURI NEW DELHI - 110064 PHONE: +91-11-45114611-30 lines, FAX: +91-11-28116248 E-mail: sales@hydmark.com		OUR REF.	HAQ/JAL/22-23/1124
		DATE	26.11.2022
M/s. Jindal Aluminium Ltd., Bhiwadi division, SP-2/333, Industrial area, Bhiwadi-301019 Alwar Distt., (Rajasthan) Tel.: 080- 27735051/ 52 Mob. 9611195368		YOUR REF.: - Your email dated- 06.11.2022	
		Kind Attn.: - Rajgopal. C. Sarda (Asst. Manager Purchase)	
		Email: rajgopal@jindalaluminium.com	

Dear Sir,
We feel pleasure in forwarding our quotation for the following:

S. NO.	DESCRIPTION	QTY.	UNIT PRICE
1.	SOLID STEM FOR BP-1 PRESS • As per your drg. no. BP1-1650-33-A3 <i>Local forged H13 Grade die steel</i>	02 Nos.	@ ₹ 4,22,000.00 Each (@ Rupees four lacs twenty two thousand only)
2.	ASSEMBLY OF FIXED TYPE DUMMY BLOCK FOR BP1 PRESS • As per your drg. no. BP1-1650-32-A1 <i>Local forged H13 Grade die steel</i>	03 Nos.	@ ₹ 1,28,000.00 Each (@ Rupees one lac twenty eight thousand only)
3.	HOT LOG SHEAR RING (CUTTER) FOR BP1 PRESS • As per your drg no - HLS-BP1-17-A3 (Log Dia 161 mm) <i>Local H13 forged steel</i>	02 Nos.	@ ₹ 1,29,000.00 Each (@ Rupees one lac twenty nine thousand only)
4.	LOG CLAMP BRACKET FOR BP1 HOT LOG SHEAR • As per your drg. no.- HLS-BP1-13-A3, PART NO.-2 <i>As per drawing MOC of BN 20</i>	01 No.	@ ₹ 74,500.00 Each (@ Rupees seventy four thousand five hundred only)

CHECK LIST

DISCOUNT: *Rate as above*

PRICE BASIS: FOR BHIWADI... *FOR JAL B W D.*

P & F: INCL / EXTRA _____

GST/IGST: *IGST: 12% Excl*

DELIVERY: *10 weeks 10 invoices*

PAYMENT: *30 days credit*

GC/WC/TC: *TC for RM*

VALIDITY: _____

Checked by: _____

Our terms & conditions of business are as per the details listed below:-

No more availability

*Rs. 4,00,000
H13 Local Market*

*Rs. 1,15,000
H13 Local Market*

Rs. 1,16,000

Rs. 67,000 Each

Discussed with Mr. Oberoy and agreed above rates.

HYDMARK APPLICON

A 5/4 6/4, PHASE II, INDUSTRIAL AREA, MAYAPURI
NEW DELHI - 110064
PHONE: +91-11-45114611-30 lines, FAX: +91-11-28116246
E-mail: sales@hydmark.com

QUOTATION

OUR REF.	HAQ/JAL/22-23/640
DATE	11.08.2022
YOUR REF.:	- Your email dated- 09.08.2022
Kind Attn.:	- Rajgopal. C. Sarda (Asst. Manager Purchase)
Email:	rajgopal@jindalaluminium.com

M/s. Jindal Aluminium Ltd.,
Bhiwadi division,
SP-2/333, Industrial area, Bhiwadi-301019
Alwar Distt., (Rajasthan)
Tel.: 080- 27735051/ 52 | Mob. | 9611195368

Dear Sir,
We feel pleasure in forwarding our quotation for the following:

S. NO.	DESCRIPTION	QTY.	UNIT PRICE
1.	SEMI FINISHED LINER FOR Ø168 CONTAINER BP1 PRESS * As per your given drawing - BP1-1650-05-A3	01 No.	Rs. 1,90,000/- @ ₹ 1,93,400.00 Each (@ Rupees one lac ninety three thousand four hundred only)

As per your given drawing - BP1-1650-05-A3

Local forged steel from market

Local decided

No market available

Discussed with Mr. Oberoi and agreed above rate

14/08/23

CHECK LIST	
DISCOUNT	ed Rate as above
PRICE BASIS	: FOR BHIWADI FOR-JAL BWP?
P & F	: INCL ✓ EXTRA
GST/GST	: -GST: 15% Extra
DELIVERY	: 10 weeks
PAYMENT	: 30 days
GC/WG/TC	: TC for RM will be provided
VALIDITY	: _____
CHECKED BY	: <i>Rajgopal</i>

Our terms & conditions of business are as per the details listed below:-

Payment Terms	Within 30 days
Price Basis	Ex - Bhiwadi.
GST	18% Extra /As applicable
Our GST No.	07AAAP02514K1ZV
HSN Code	84129090
Delivery	3 - 4 Weeks after the firm placement of order with drawing approval
Packing & Forwarding	Nil
Freight	Nil
Validity of quotation	15 days.

We shall look forward to receipt of your valuable order.

Thanking you,
Yours Sincerely,

A.P.S. Oberoi

Enclosures:		
S. No.	Description	Page

Golden Engineering & Enterprises

Address: Kamardanga, Pallabpukur, Santragachi, Howrah - 711104
 State: WEST BENGAL(19)

GSTIN: 19AESPM2302K227

PAN: AESPM2302K

Mobile: 9630250045

Phone: 033 2667 2449

Website: www.goldenengineering.co.in

Email: golden.mondal@gmail.com

QUOTATION

Quotation No. : QUO/Q/584/2022-23 REVISED

Date: 12-01-2023

Ref./PO No. : EN220800731

Ref./PO Date : 06-11-2022

QUOTATION TO (DETAILS OF RECEIVER)

Name: JINDAL ALUMINIUM LIMITED
 (BHWADI DIVISION)
 Address: SP-2/333, RICCO INDUSTRIAL
 AREA, BHWADI, ALWAR, BHWADI,
 RAJASTHAN, 301019
 Mobile:
 GST No: 08AAACJ324M12H
 State : RAJASTHAN
 State Code: 8

S.No.	Item Name Description	HSN/SAC	UoM	Qty	Rate	Dis(%)
1	CLAMP BRACKET FOR BP1 HOT LOG SHEAR AS PER YOUR DRAWING NO - HLS-BP1-13-A3, ITEM NO - 1, MATERIAL: EN-24 WITH HARDENING	8302	Sets		25676	0.00
2	CLAMP BRACKET FOR BP1 HOT LOG SHEAR AS PER YOUR DRAWING NO - HLS-BP1-13-A3, ITEM NO - 2, MATERIAL: EN-24 WITH HARDENING	8302	Sets		25676	0.00
3	CUTTER 8 INCH FOR HOT LOG SHEAR BP1 PRESS AS PER YOUR DRAWING NO - HLS-BP1-17-A3, MATERIAL H-13 WITH HARDNESS 48 - 50 RC	7315	Sets		92600	0.00
4	SOLID STEM FOR BAYONET TYPE DUMMY BLOCK FOR 168 MM DIA CONTAINER-BP1 AS PER YOUR DRAWING NO - BP1-1699-33-A3), MATERIAL H13 WITH HARDENING.	9307	Pieces		325000	0.00

EN-24

EN-24

H13
forged steel

Imported

No make confirmed

Rs. 24400/-

Rs. 24400/-

Rs. 87500/-

Rs. 308750/-

CHECK LIST

ed Rate as above
 for Bhwadi.

PRICE BASIS : FOR BHWADI 4 468852

E & O E

Terms & Conditions:

RATES - Ex. Works, Howrah.
 G.S.T - Extra 18% as applicable.
 PAYMENT - 30 days Credit Maximum.
 DELIVERY - Depend on your Order.
 PACKING - Inclusive.
 INSPECTION - At Your Side.
 VALIDITY - 15 days from the date hereof.

EST/AGST

DELIVERY

PAYMENT

GC/MC/TC

VALIDITY

CHECKED BY :

✓
 18% Ex. Works
 10 weeks
 30 days credit
 cc will be provided.

Rajgopd.

For Golden Engineering & Enterprises

Discount with
 Mr. Press and refund
 above sale

12/01/23

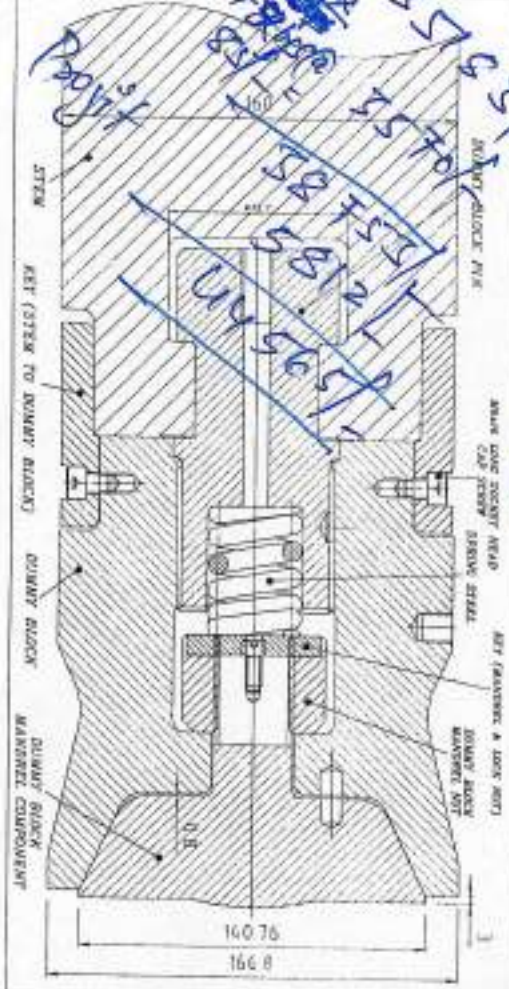
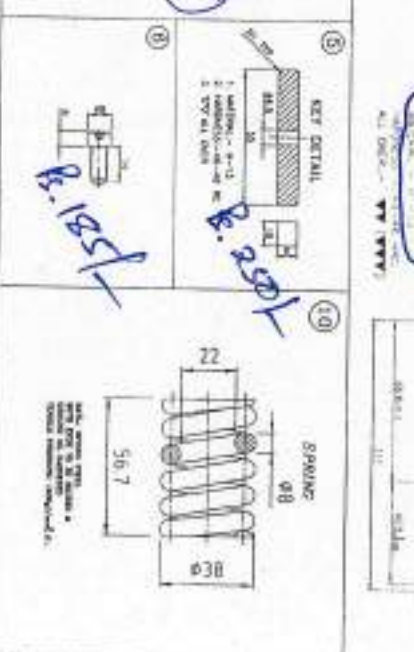
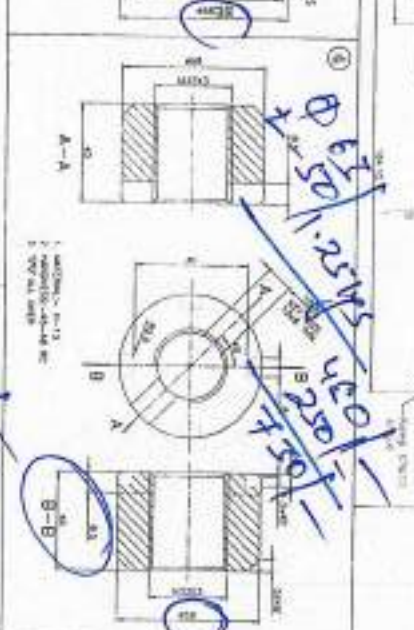
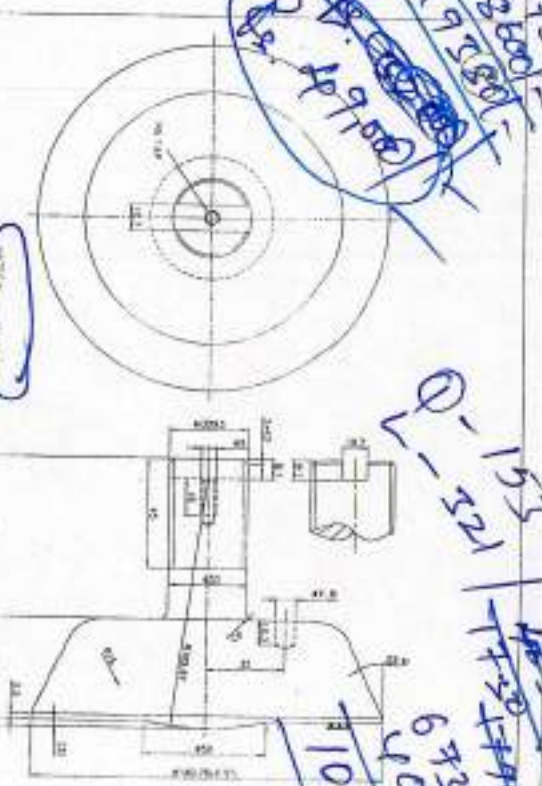

ITEM NO.	DESCRIPTION	QTY	REMARKS
01	SHAFT	1	SEE DETAIL
02	WASHER	1	SEE DETAIL
03	WASHER	1	SEE DETAIL
04	WASHER	1	SEE DETAIL
05	WASHER	1	SEE DETAIL
06	WASHER	1	SEE DETAIL
07	WASHER	1	SEE DETAIL
08	WASHER	1	SEE DETAIL
09	WASHER	1	SEE DETAIL
10	WASHER	1	SEE DETAIL
11	WASHER	1	SEE DETAIL
12	WASHER	1	SEE DETAIL
13	WASHER	1	SEE DETAIL
14	WASHER	1	SEE DETAIL
15	WASHER	1	SEE DETAIL
16	WASHER	1	SEE DETAIL
17	WASHER	1	SEE DETAIL
18	WASHER	1	SEE DETAIL
19	WASHER	1	SEE DETAIL
20	WASHER	1	SEE DETAIL
21	WASHER	1	SEE DETAIL
22	WASHER	1	SEE DETAIL

NOTE:-
 1. DIMENSIONS ARE IN MILLIMETERS.
 2. DIMENSIONS ARE TO BE TAKEN TO THE CENTER OF THE HOLE UNLESS OTHERWISE SPECIFIED.
 3. DIMENSIONS ARE TO BE TAKEN TO THE SURFACE UNLESS OTHERWISE SPECIFIED.
 4. DIMENSIONS ARE TO BE TAKEN TO THE CENTER OF THE HOLE UNLESS OTHERWISE SPECIFIED.
 5. DIMENSIONS ARE TO BE TAKEN TO THE SURFACE UNLESS OTHERWISE SPECIFIED.

JINDAL ALUMINIUM LTD.
 1650 TON PRESS (BP-1)
 BH-1-1050-32-A1

Turning
 Cut - 25 to 25 mm
 1st dia 5030
 2nd dia 3500
 3rd dia 1650
 4th dia 700
 5th dia 350
 6th dia 1650
 7th dia 700
 8th dia 350

MAT'L: - HOT DIE CAST AL H13
 HARDNESS: - 58 HRC

Final cost & 3,55,000

Required
 765
 755

Φ - 353 - Rod - 590 lgs @ 25/- = 2,28,950/-
 Φ 165 - 353 - Rod - 590 lgs @ 25/- = 2,28,950/-
 Φ 165 - 353 - Rod - 590 lgs @ 25/- = 2,28,950/-
 Φ 165 - 353 - Rod - 590 lgs @ 25/- = 2,28,950/-
 Φ 165 - 353 - Rod - 590 lgs @ 25/- = 2,28,950/-

165
 350
 353
 Availability

JINDAL ALUMINIUM LTD.		DRAWING NO.	
SP-2/333, INDUSTRIAL AREA BHIVADI, RAJASTHAN-301019		1850-05-A1	
DRN.	DATE	CHKD.	DATE

SCALE: 1:1
 DATE: 2.12.1915

2,12,1915

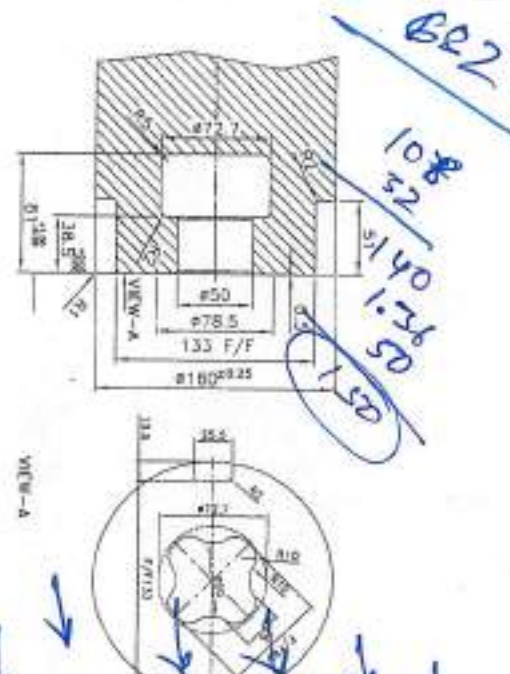
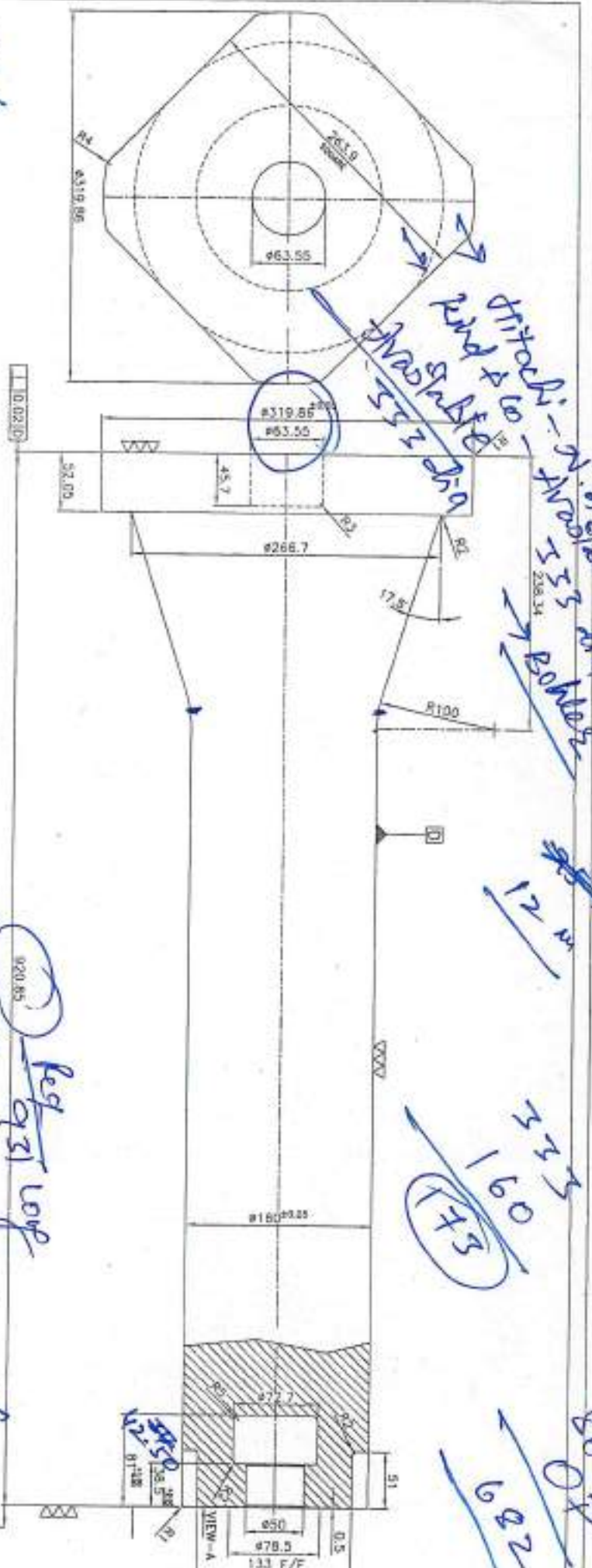

→ Rem - 637ys @ R. 40sf-pep - 2,57,985f -
 → less : 52ep - Appr - 15qps @ R. 29f - 5,850f =
 Diff of 1300000 - 487ys @ R. 2sf =
 Machining (Turning) millip, slotting/
 Part of Machine
 → Find Machine
 → Part (Cost Weight, standards)

Req 931 top

1. MATERIAL - 4139SF
2. HARDNESS - 46-48 HRC
3. QUANTITY REQUIRED - 1 NO.
4. SURFACE REQUIRED - FREE FROM SCORES
5. ALL OVER - 5.000f

3,34,530 / BLOCK STEM
 TOTAL STOCK LENGTH - 184.15+970.85 = 1105

JINDAL ALUMINIUM		DATE		NAME	
SP-2/203 INDUSTRIAL AREA		15/08/23		JANU	
MATERIAL - 4139SF		SCALE		1:1	
ALL DIMENSIONS ARE IN MILLIMETERS		DRAFTER		3/16/23	
SCALE - SOLID STEM FOR BAYONET		DRAWING NO.		BP1-1550-33-A3	
(FOR 4139SF CONTAINER-9P1)					

31 kg
15 kg

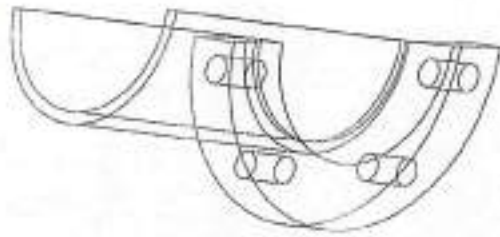

Final Rate
Rs. 24000/-

4 NOS. THRU HOLE Ø22 ON 120.6 PCD



**PART NO.-1
BILLET CLAMP**

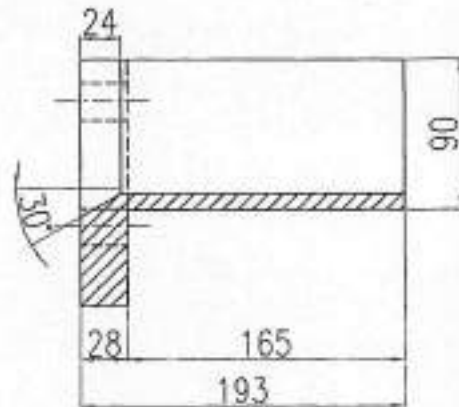

SEC.-AA

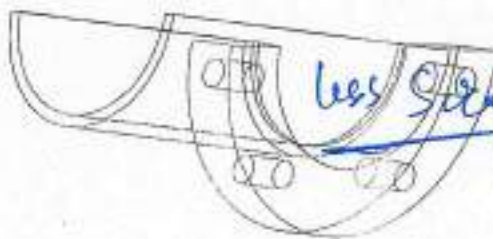

→ 113kg @ Rs. 150/- = 16950/-
less Scrap → 45kg @ Rs. 39/- = 1755/-
15195



**PART NO.-2
LOG CLAMP**

→ 113kg @ Rs. 150/- = 16950/-
less Scrap → 45kg @ Rs. 39/- = 1755/-
15195
Machining 4500/-
Drilling 200/-
Grinding 200/-
60kg @ 85/- = 5780/-
25675
Profit 10% = 2567/-
28242/-

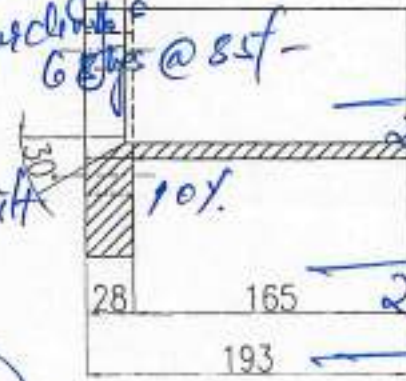

SEC.-BB

Final Rate
Rs. 24000/-

MATERIAL:- EN24
HARDNESS:- 30-35 HRC

JINDAL ALUMINIUM LTD.

SP-2/333, INDUSTRIAL AREA,
BHIWADI, RAJASTHAN-301019

ALL DIMENSIONS ARE IN mm. UNLESS OTHERWISE SPECIFIED

SCALE 1:1

CLAMP BRACKET FOR BP1
HOT LOG SHEAR (161mm LOG DIA)

	NAME	DATE
DRN.	VIKAS	30.07.22
CKD.	[Signature]	30.7.22
APPD.	[Signature]	30.7.22

DRAWING NO.
HLS-BP1-13-A3

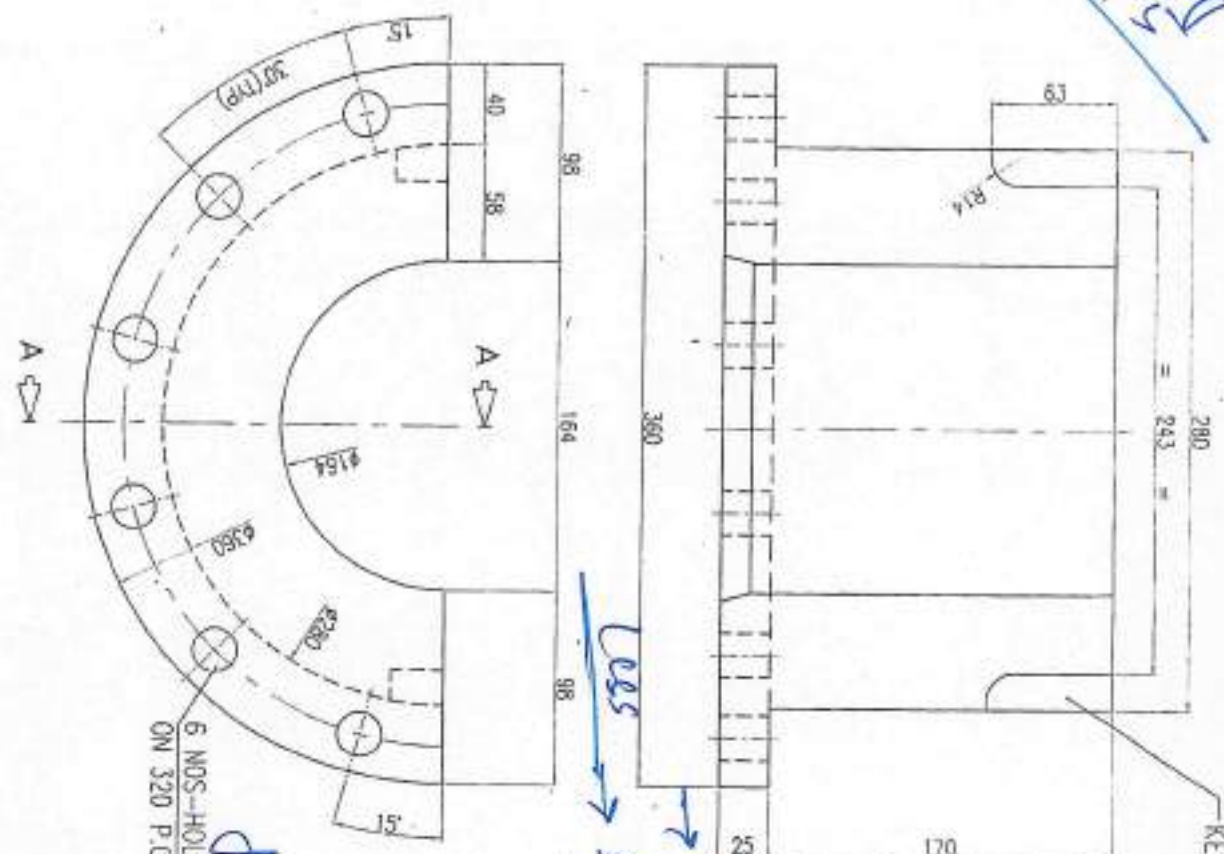

KEY WAY - 53(L) X 18.5(W) X 26(DEEP)

6 NOS - HOLE #22 THRU ON 320 P.C.D.
Handy 1st @ 817
Machine B/H/H/D Drill

Less
 → Rm - 170ys @ 385f = 65450 / -
 → Scap - 45ys @ 39 / - = 1755 / -
 63695 / -



Final
 86900 / -



ISOMETRIC VIEW

MATERIAL: H-13
 HARDNESS: -48-50 HRC

JINDAL ALUMINIUM LTD.		DATE
DR-2/2008 SHEET NO. 001		14/3/20
BIRKBECK MANUFACTURING SYSTEMS		14/3/20
ALL DIMENSIONS ARE IN MM. UNLESS OTHERWISE SPECIFIED	NO.	14/3/20
CUTTER #6" FOR HOT	DATE	14/3/20
LOG SHEAR BP1 PRESS	DRYING NO.	14/3/20
	HIS-001-17-A3	

SEC-8696

OK
 20/11/17