

PROPOSAL DRAWING

Q01598

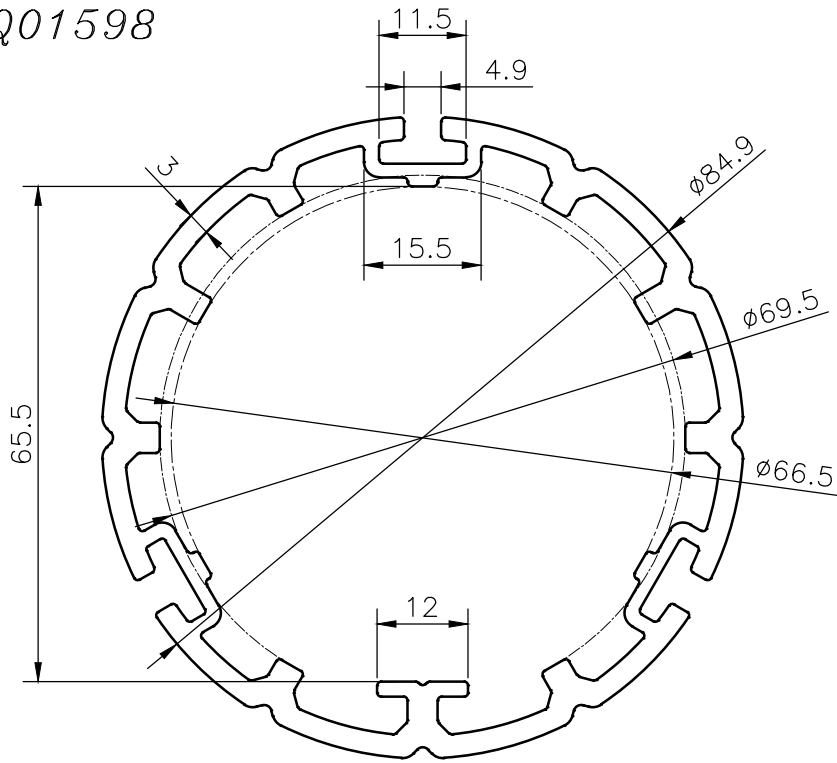

Area:1053.177 Sq.mm. | Perimeter:344.51 mm. | Weight:2.844 Kg./mtr.

PROPOSAL DRAWING

Q01599

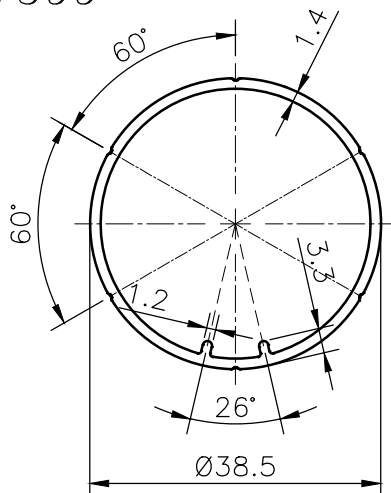

Area:166.569 Sq.mm. | Perimeter:122.035 mm. | Weight:0.45 Kg./mtr.