

PROPOSAL DRAWING
Q01600

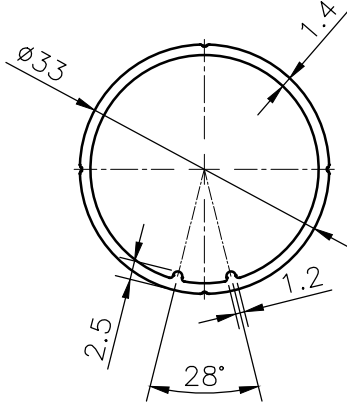

Area:140.795 Sq.mm. | Perimeter:104.39 mm. | Weight:0.38 Kg./mtr.

PROPOSAL DRAWING
Q01601

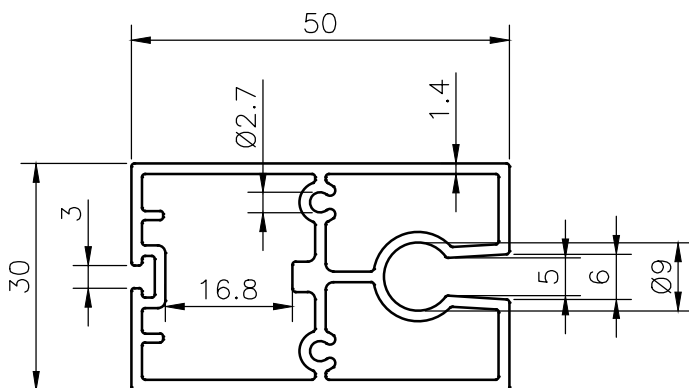

Area:354.875 Sq.mm. | Perimeter:202.454 mm. | Weight:0.958 Kg./mtr.