

PROPOSAL DRAWING
Q01602

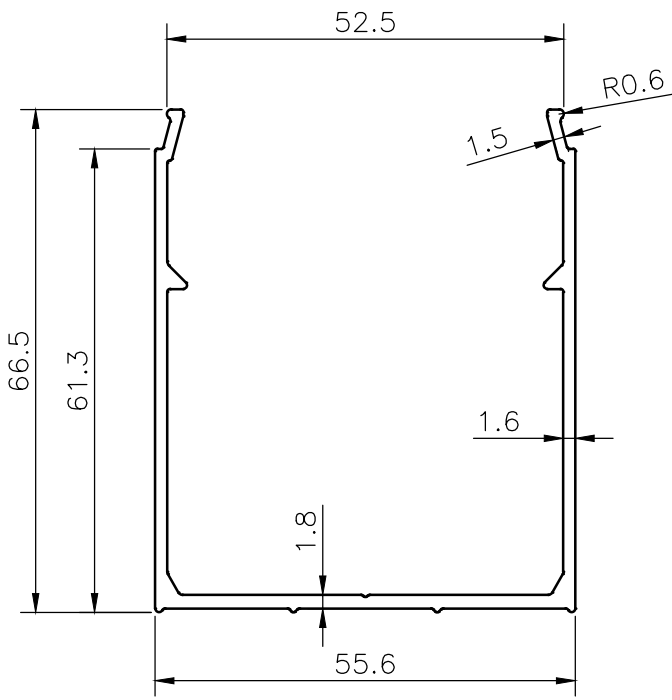

Area:325.639 Sq.mm. | Perimeter:381.25mm. | Weight:00.879 Kg./mtr.

PROPOSAL DRAWING
Q01603

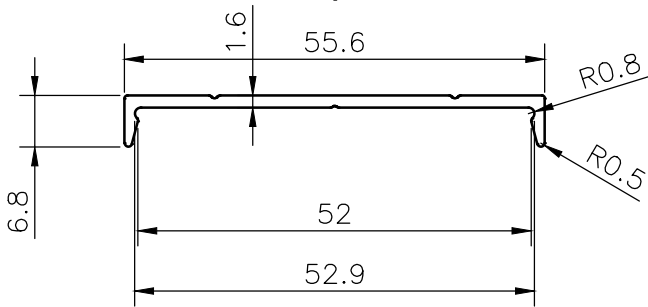

Area:102.687 Sq.mm. | Perimeter:133.77mm. | Weight:00.277 Kg./mtr.

