

PROPOSAL DRAWING  
Q01606

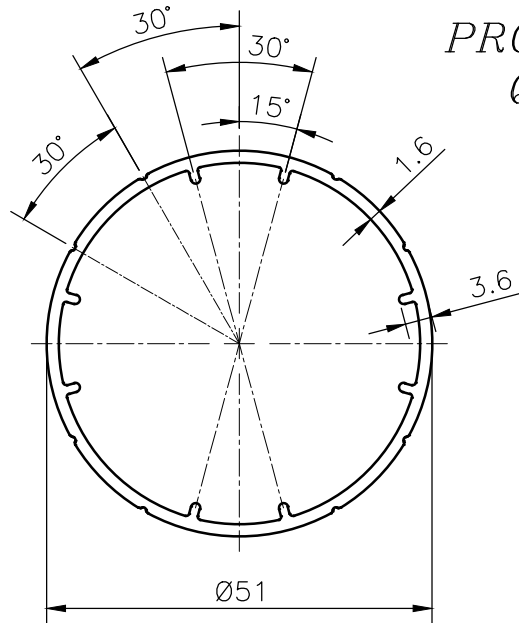

Area:264.522 Sq.mm. | Perimeter:162.251 mm. | Weight:0.714 Kg./mtr.

PROPOSAL DRAWING  
Q01607

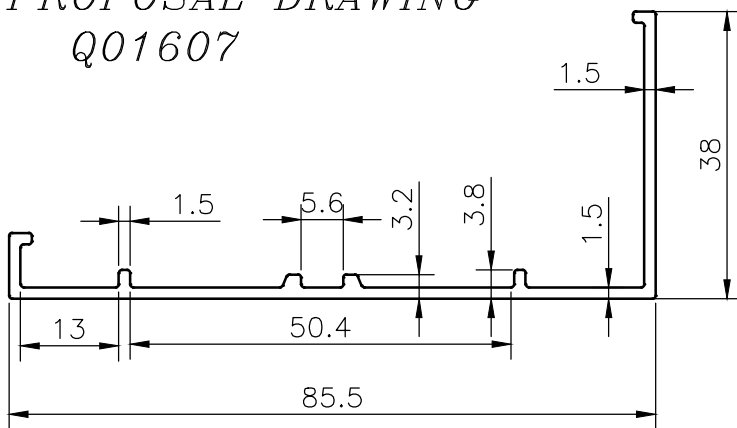

Area:212.373 Sq.mm. | Perimeter:277.9mm. | Weight:00.573 Kg./mtr.