

Q01718
PROPOSAL DRAWING

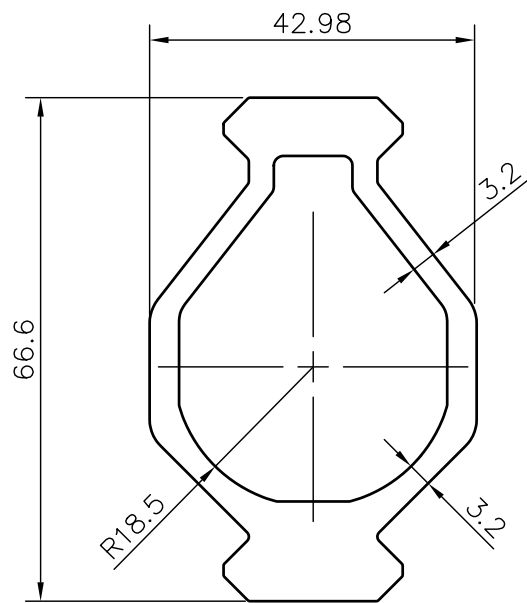

Area: 822.922 Sq.mm. | Perimeter: 197.09 mm. | Weight: 2.222 Kg./mtr.