



JINDAL ALUMINIUM LTD.

BANGALORE-560073 (INDIA)

PROPOSED DRAWING

Q00787

DATE:- 27.07.2023

ALLOY TEMPER- 6005-T6

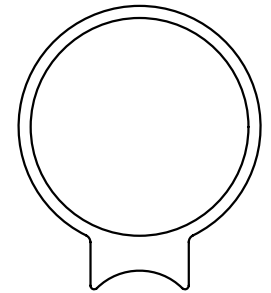
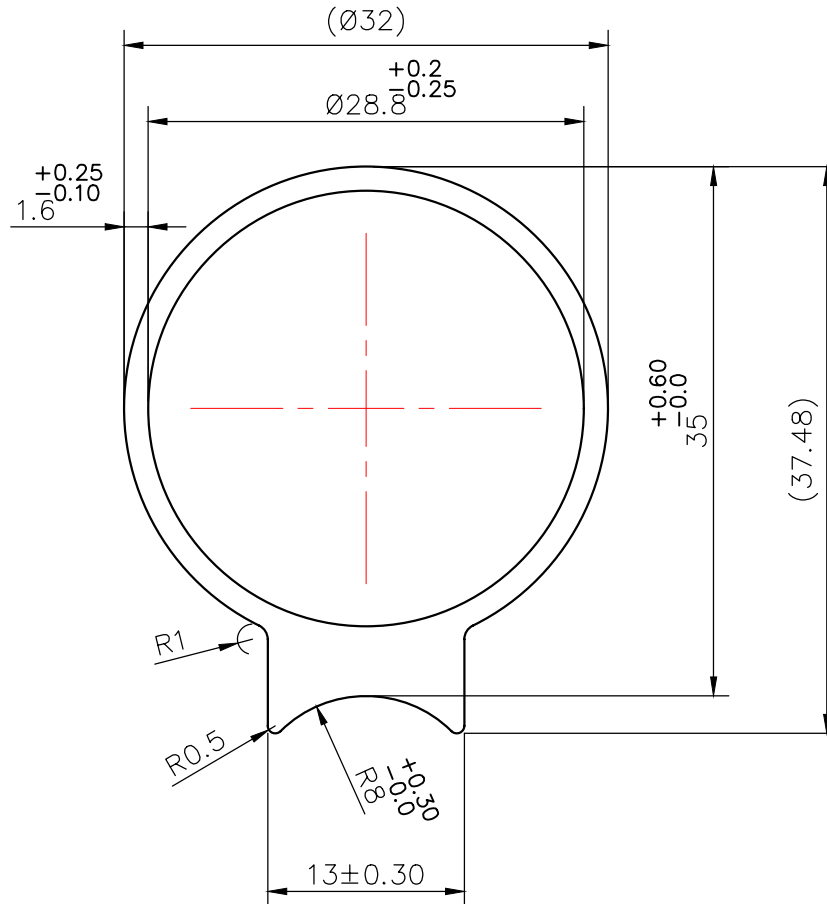

SCALE 1:1

SCALE 2:1

Area: 210.104 Sq.mm. | Perimeter: 114.477 mm. | Weight: 0.567 Kg./mtr.