

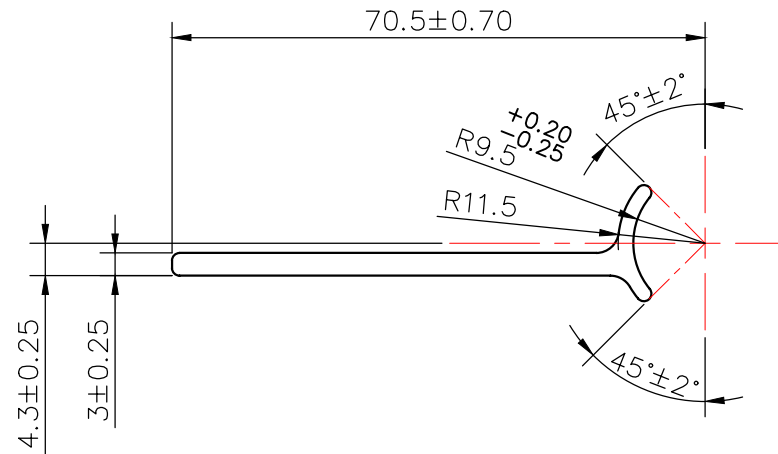

JINDAL ALUMINIUM LTD.
BHIWADI-301019 (INDIA)

PROPOSED DRAWING
09.08.2023

Q00869



ALLOY -6063 T6

Area: 212.118 Sq.mm.
Perimeter: 151.55mm.
Weight: 0.573 Kg./mtr.

CUSTOMER NAME :- MACRO AUTO TECH.