

ALUM. PROFILE
(AW_AL11)

ALLOY - 6063 - T6
FINISH - ANODIZED/
POWDER COATING

PROPOSED DRAWING

Q00969

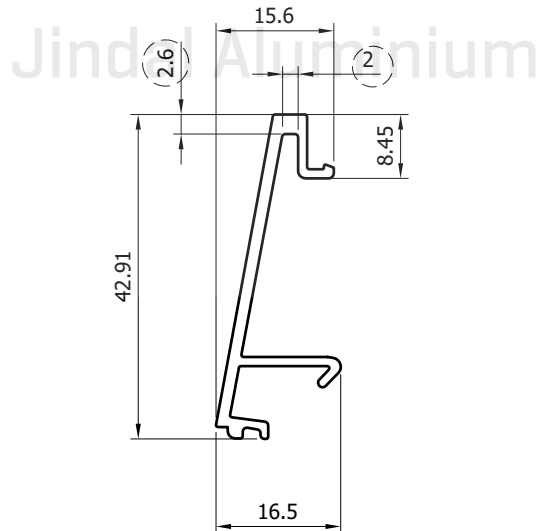

Area: 118.638 Sq.mm. | Perimeter: 156.87mm. | Weight: 00.32 Kg./mtr.