

M/s.ADYANCED WINDOW AND DOOR SYSTEMS
PROPOSED DRAWING

Q02289 ALLOY 6063 T6

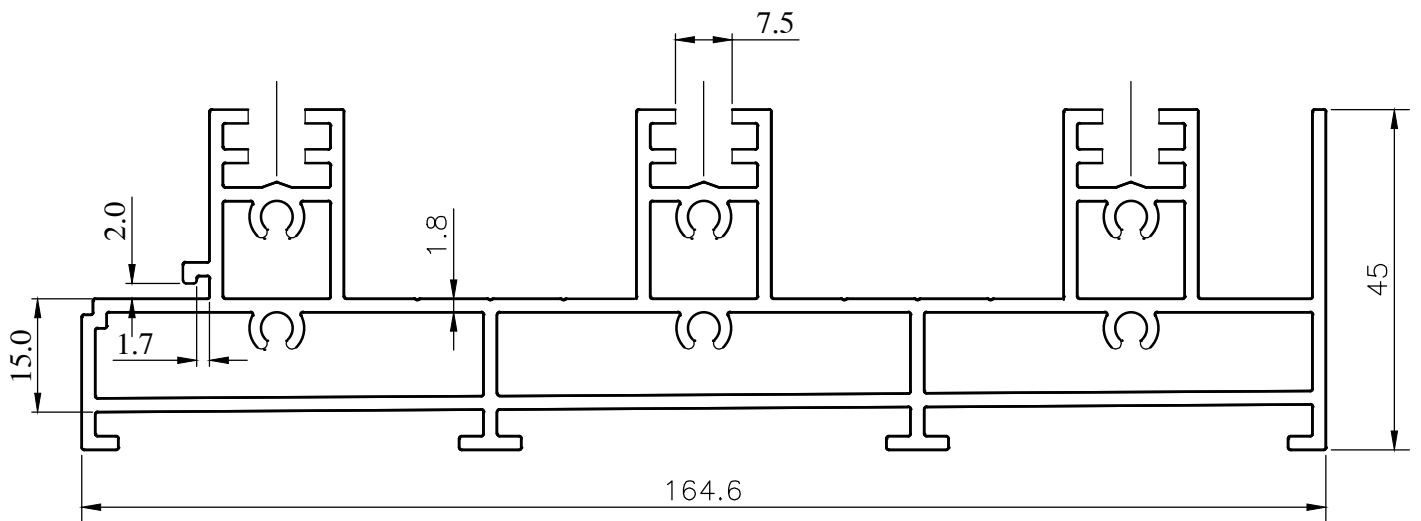

PROPOSED DRAWING

Q02290 ALLOY 6063 T6

