

PROPOSED DRAWING

Q02297 ALLOY 6063 T6

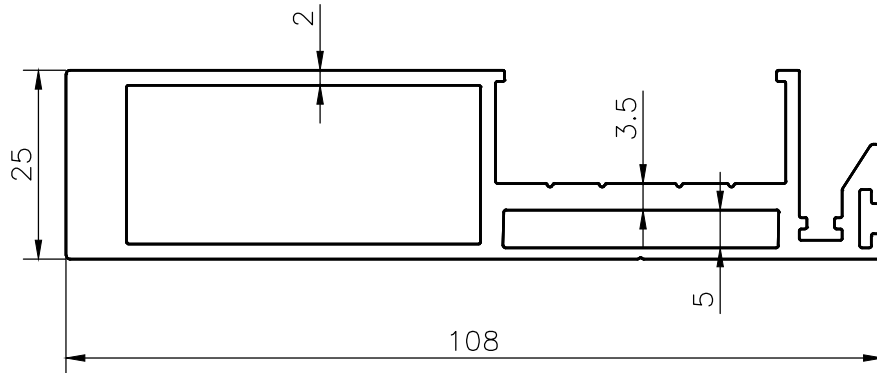

PROPOSED DRAWING

Q02298 ALLOY 6063 T6

