

Q01231
PROPOSAL DRAWING

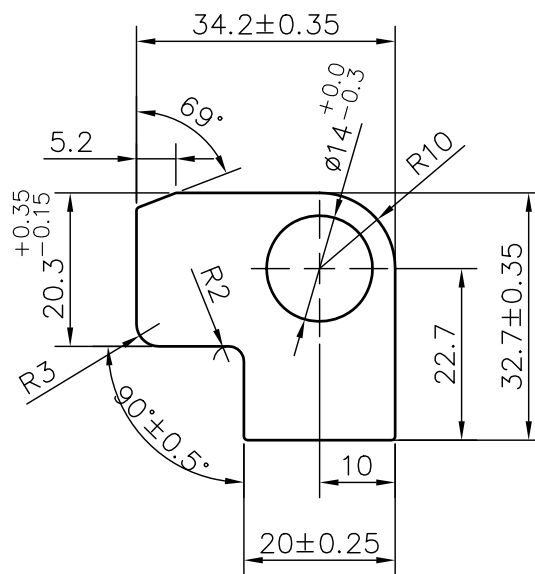

SCALE 1:1

Area: 760.47 Sq.mm. | Perimeter: 125.219 mm. | Weight: 2.053 Kg./mtr.