

Q01267  
PROPOSAL DRAWING

  
SCALE 1:1

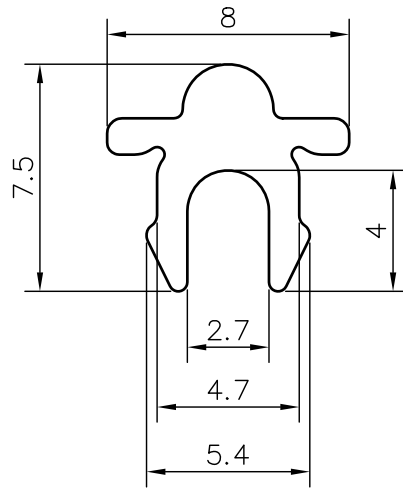

SCALE 4:1

Area: 24.66 Sq.mm. | Perimeter: 35.81mm. | Weight: 00.067 Kg./mtr.