

Q01282
PROPOSAL DRAWING

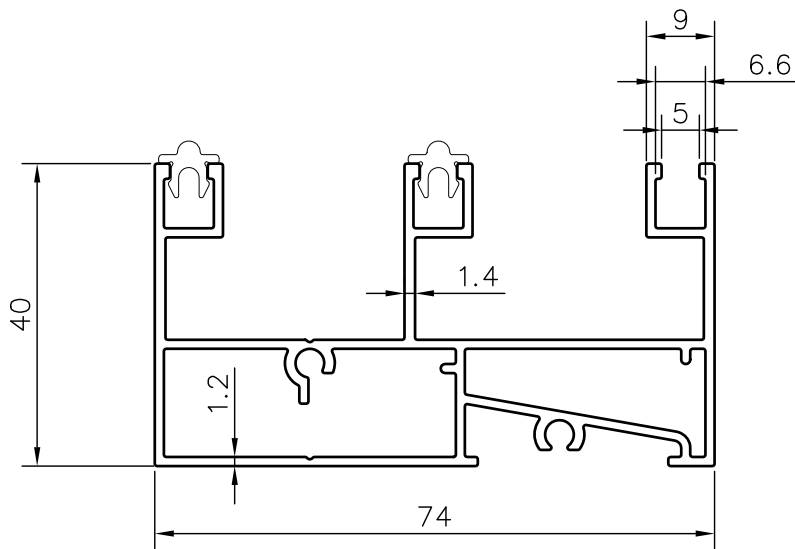

SCALE 1:1

Area: 429.982 Sq.mm. | Perimeter: 455.309 mm. | Weight: 1.161 Kg./mtr.