

Q01453  
PROPOSAL DRAWING

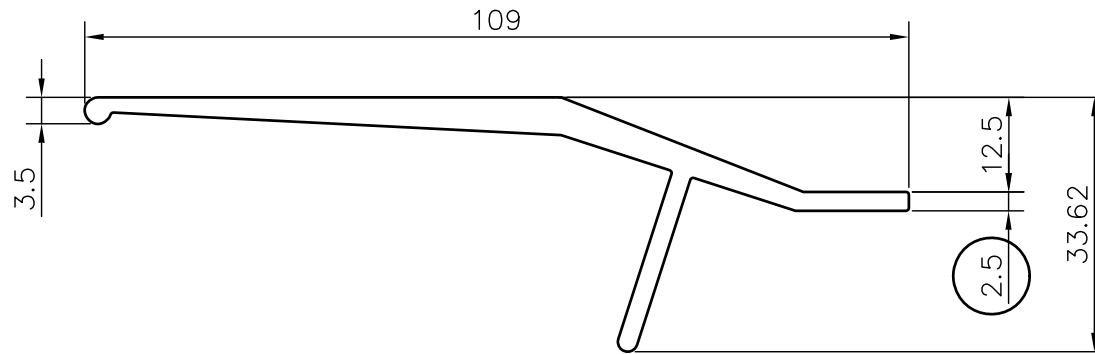

Area: 441.319 Sq.mm. | Perimeter: 274.56mm. | Weight: 1.192 Kg./mtr.