

Q01457

PROPOSAL DRAWING

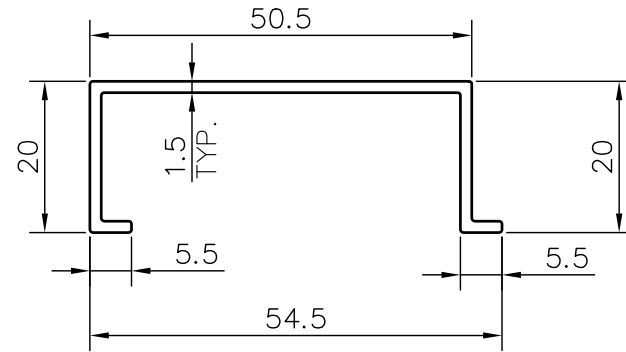

Area: 143.113 Sq.mm. | Perimeter: 191.94mm. | Weight: 00.386 Kg./mtr.