

2005

13003

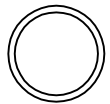

1:1

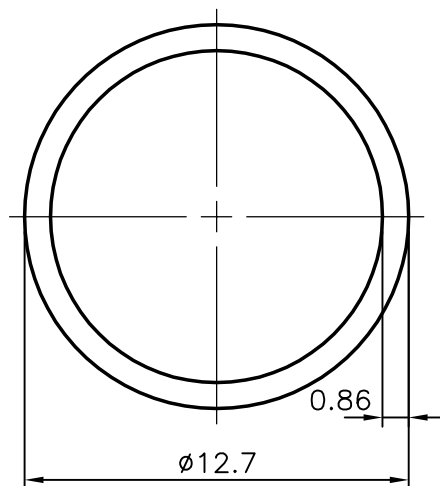

SYMBOL OF QUALITY
AN ISO 9001 COMPANY

JINDAL ALUMINIUM LTD.
BANGALORE-560073 (INDIA)

	NAME	DATE
DRAWN	j.p.kaushik	05.10.2005
CHECKED		
APPROVED		
SCALE		4:1
AREA mm ²		31.989
PERIMETER mm.		39.898
WEIGHT kg/m		0.086
DRAWING No.		SECTION No.
2005		—
13004		13004

1. ALL DIMENSIONS ARE IN mm.
2. ROUND OFF ALL SHARP CORNERS WITH 0.40 mm.
3. TOLERANCES WILL BE AS PER IS: 2673-2002 UNLESS OTHERWISE SPECIFIED

PARTY'S NAME	—
PARTY'S DRAWING No.	—
ALLOY & TEMPER	HE9 WP
DESCRIPTION	ROUND TUBE