

2012

13011

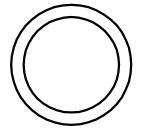

1:1

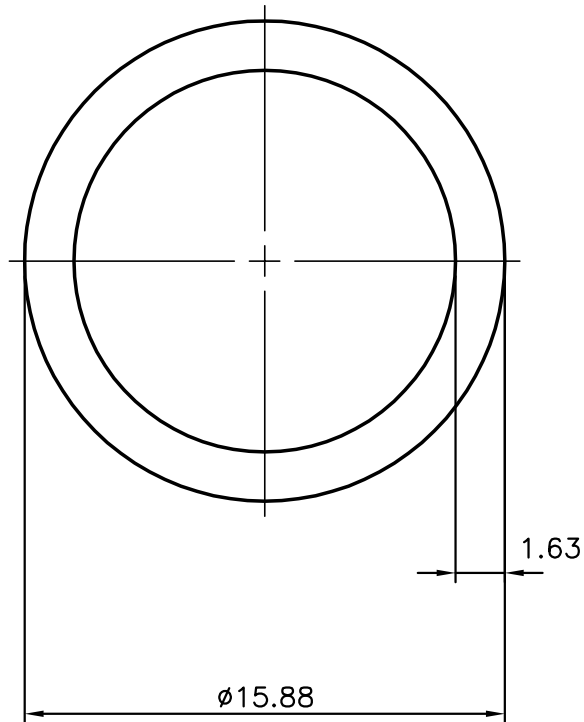

SYMBOL OF QUALITY
AN ISO 9001 COMPANY

JINDAL ALUMINIUM LTD.
BANGALORE-560073 (INDIA)

	NAME	DATE
DRAWN	j.p.kaushik	05.10.2005
CHECKED		
APPROVED		

1. ALL DIMENSIONS ARE IN mm.
2. ROUND OFF ALL SHARP CORNERS WITH 0.40 mm.
3. TOLERANCES WILL BE AS PER IS: 2673-2002 UNLESS OTHERWISE SPECIFIED

SCALE	4:1
AREA mm ²	72.971
PERIMETER mm.	49.888
WEIGHT kg/m	0.197

PARTY'S NAME	—	DRAWING No.	2012	SECTION No.	—
PARTY'S DRAWING No.	—		13011		13011
ALLOY & TEMPER	HE9 WP				
DESCRIPTION	ROUND TUBE				