

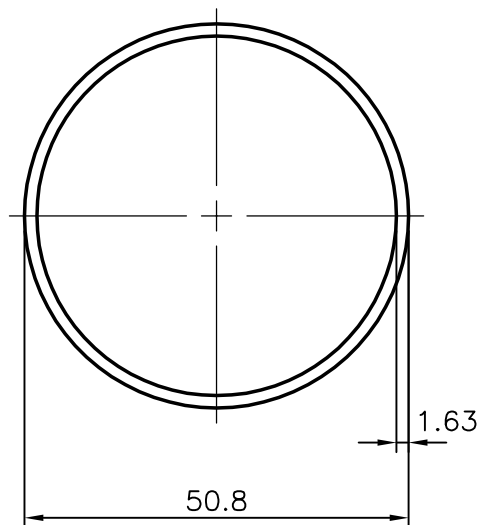

2035

13031



 SYMBOL OF QUALITY AN ISO 9001 COMPANY	JINDAL ALUMINIUM LTD. <i>BANGALORE-560073 (INDIA)</i>	NAME	DATE
		DRAWN	j.p.kaushik
1. ALL DIMENSIONS ARE IN mm. 2. ROUND OFF ALL SHARP CORNERS WITH 0.40 mm. 3. TOLERANCES WILL BE AS PER IS: 2673-2002 UNLESS OTHERWISE SPECIFIED		CHECKED	
		APPROVED	
PARTY'S NAME -		SCALE	1:1
		AREA mm ²	251.79
PARTY'S DRAWING No. -		PERIMETER mm.	159.593
		WEIGHT kg/m	0.680
ALLOY & TEMPER HE9 WP		DRAWING No.	SECTION No.
		2035	2035
DESCRIPTION ROUND TUBE		13031	13031