

2057

13048

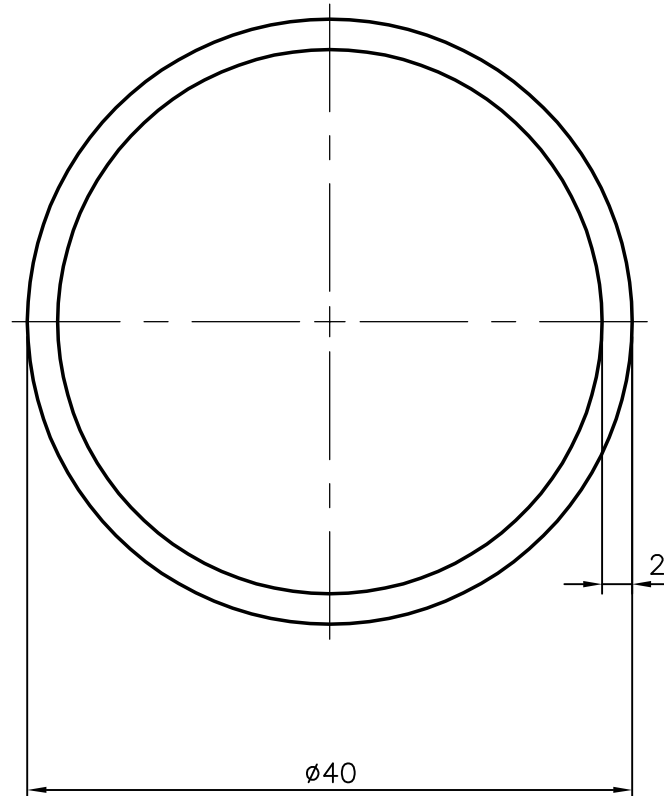

SYMBOL OF QUALITY
AN ISO 9001 COMPANY

JINDAL ALUMINIUM LTD.
BANGALORE-560073 (INDIA)

	NAME	DATE
DRAWN	J.P.KAUSHIK	06.10.2005
CHECKED		
APPROVED		
SCALE	2:1	
AREA mm ²	238.761	
PERIMETER mm.	125.664	
WEIGHT kg/m	0.645	
DRAWING No.	SECTION No.	
2057	2057	
13048	13048	

1. ALL DIMENSIONS ARE IN mm.
2. ROUND OFF ALL SHARP CORNERS WITH 0.40 mm.
3. TOLERANCES WILL BE AS PER IS: 2673-1979 UNLESS OTHERWISE SPECIFIED

PARTY'S NAME	-
PARTY'S DRAWING No.	-
ALLOY & TEMPER	HE9 WP
DESCRIPTION	ROUND TUBE