

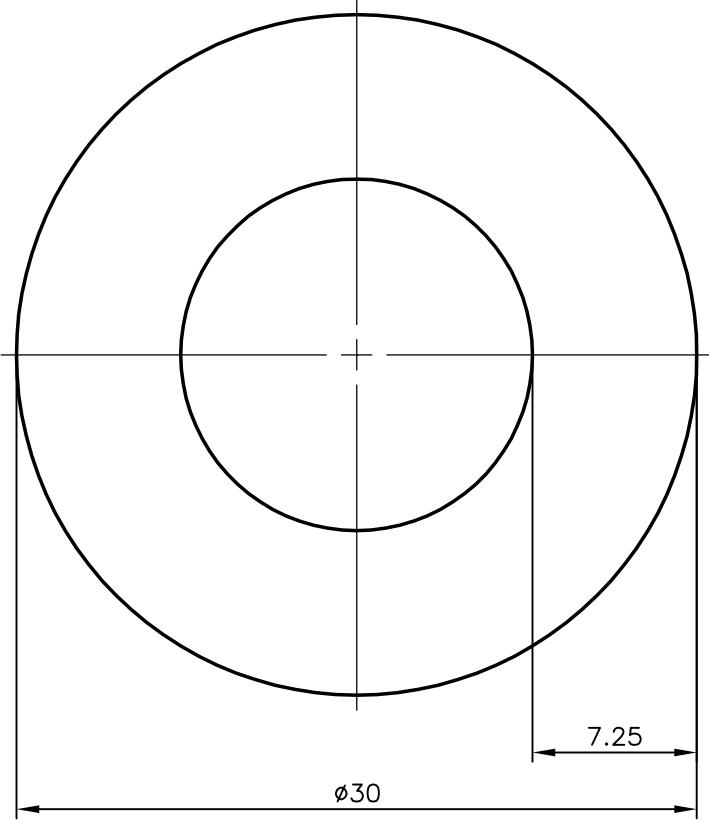

2092
13068
—

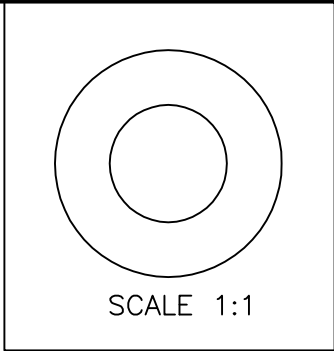

 SYMBOL OF QUALITY AN ISO 9001 COMPANY	JINDAL ALUMINIUM LTD. BANGALORE-560073 (INDIA)	NAME		DATE
		DRAWN	PRASANNA.H.	21-12-2006
1. ALL DIMENSIONS ARE IN mm. 2. ROUND OFF ALL SHARP CORNERS WITH 0.40 mm. 3. TOLERANCES WILL BE AS PER IS:2673-2002 UNLESS OTHERWISE SPECIFIED		CHECKED		
		APPROVED		
PARTY'S NAME —		SCALE		3:1
		AREA mm ²		518.166
PARTY'S DRAWING No. —		PERIMETER mm.		94.248
		WEIGHT kg/m		1.399
ALLOY & TEMPER AS PER REQUIREMENT		DRAWING No.	SECTION No.	
		2092	2092	
DESCRIPTION ROUND TUBE		13068	13068	
		—	—	