

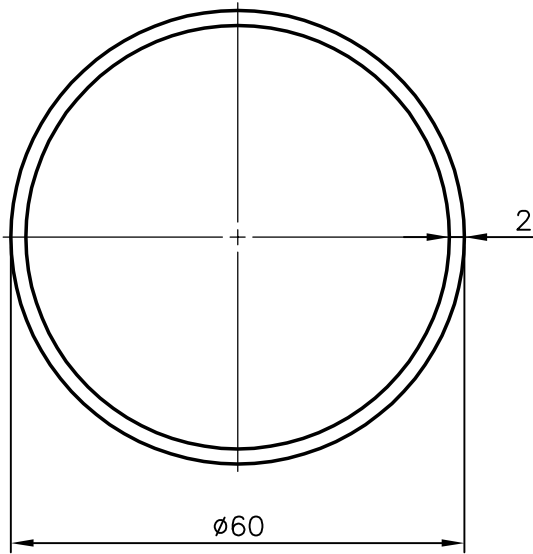

2101
13075
—



 SYMBOL OF QUALITY AN ISO 9001 COMPANY	JINDAL ALUMINIUM LTD. BANGALORE-560073 (INDIA)		NAME	DATE
		DRAWN	PRASANNA.H.	21-12-2006
1. ALL DIMENSIONS ARE IN mm. 2. ROUND OFF ALL SHARP CORNERS WITH 0.40 mm. 3. TOLERANCES WILL BE AS PER IS:2673-2002 UNLESS OTHERWISE SPECIFIED		CHECKED		
		APPROVED		
PARTY'S NAME —		SCALE		1:1
		AREA mm ²		364.425
PARTY'S DRAWING No. —		PERIMETER mm.		188.496
		WEIGHT kg/m		0.984
ALLOY & TEMPER AS PER REQUIREMENT		DRAWING No.	SECTION No.	
		2101	2101	
DESCRIPTION ROUND TUBE		13075	13075	
		—	—	