

2171

13126

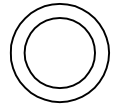

SCALE 1:1

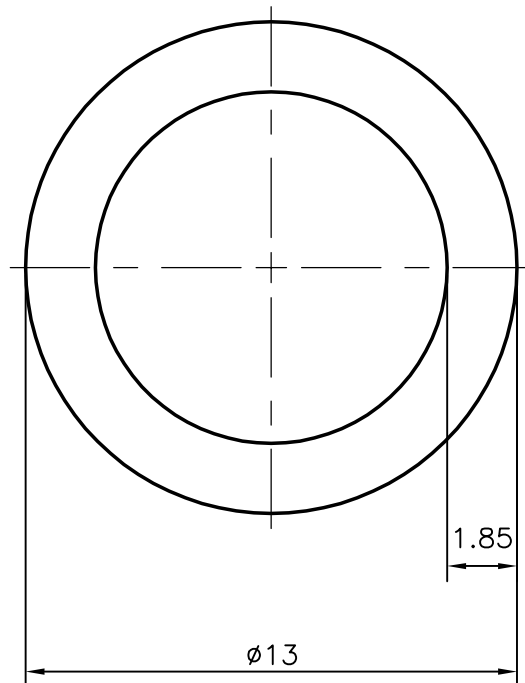

SYMBOL OF QUALITY
AN ISO 9001 COMPANY

JINDAL ALUMINIUM LTD.
BANGALORE-560073 (INDIA)

	NAME	DATE
DRAWN	PRASHANT	05-12-2006
CHECKED		
APPROVED		
SCALE		5:1
AREA mm ²		64.803
PERIMETER mm.		40.841
WEIGHT kg/m		0.175
DRAWING No.	SECTION No.	
2171	2171	
13126	13126	

1. ALL DIMENSIONS ARE IN mm.
2. ROUND OFF ALL SHARP CORNERS WITH 0.40 mm.
3. TOLERANCES WILL BE AS PER IS:2673-2002 UNLESS OTHERWISE SPECIFIED

PARTY'S NAME	GENERAL CATEGORY
PARTY'S DRAWING No.	-
ALLOY & TEMPER	HE9 WP
DESCRIPTION	ROUND TUBE