

2179

13133

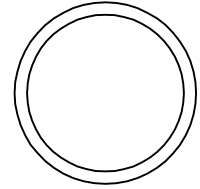

SCALE 1:1

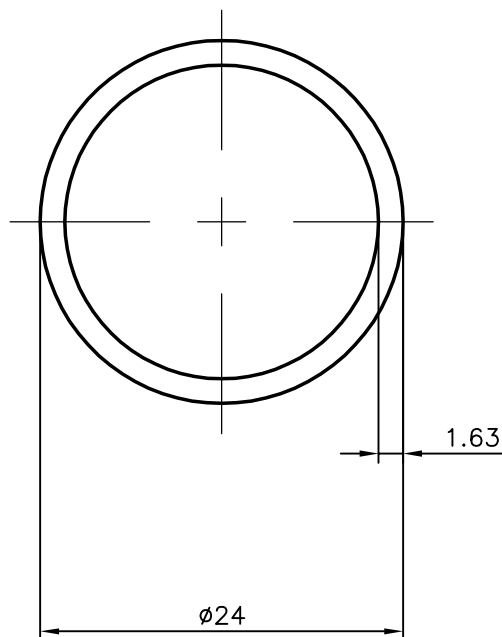

SYMBOL OF QUALITY
AN ISO 9001 COMPANY

JINDAL ALUMINIUM LTD.
BANGALORE-560073 (INDIA)

	NAME	DATE
DRAWN	PRASHANT	06-12-2006
CHECKED		
APPROVED		
SCALE		2:1
AREA mm ²		114.552
PERIMETER mm.		75.398
WEIGHT kg/m		0.309
DRAWING No.	SECTION No.	
2179	2179	
13133	13133	

1. ALL DIMENSIONS ARE IN mm.
2. ROUND OFF ALL SHARP CORNERS WITH 0.40 mm.
3. TOLERANCES WILL BE AS PER IS:2673-2002 UNLESS OTHERWISE SPECIFIED

PARTY'S NAME	GENERAL CATEGORY
PARTY'S DRAWING No.	-
ALLOY & TEMPER	HE9 WP
DESCRIPTION	ROUND TUBE