

2199

13145

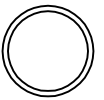

1:1

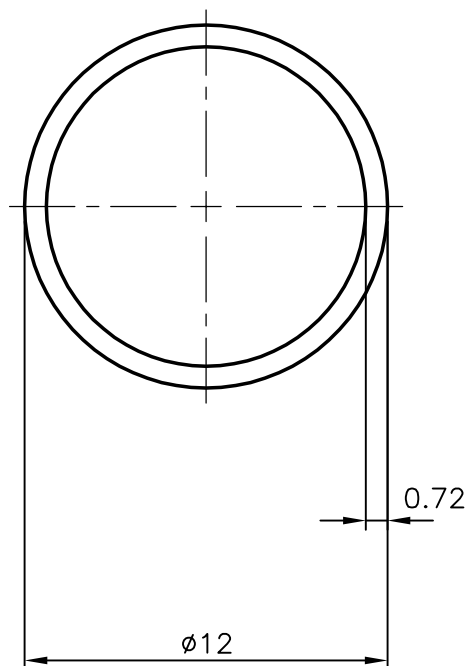

SYMBOL OF QUALITY
AN ISO 9001 COMPANY

JINDAL ALUMINIUM LTD.
BANGALORE-560073 (INDIA)

	NAME	DATE
DRAWN	J.P.KAUSHIK	07-10-2005
CHECKED		
APPROVED		

1. ALL DIMENSIONS ARE IN mm.
2. ROUND OFF ALL SHARP CORNERS WITH 0.40 mm.
3. TOLERANCES WILL BE AS PER IS: 2673-2002 UNLESS OTHERWISE SPECIFIED

SCALE	4:1
AREA mm ²	25.515
PERIMETER mm.	37.699
WEIGHT kg/m	0.068

PARTY'S NAME

-

DRAWING No.

SECTION No.

PARTY'S DRAWING No.

-

2199

2199

ALLOY & TEMPER

HE9 WP

13145

13145

DESCRIPTION

ROUND TUBE