

2297

13224

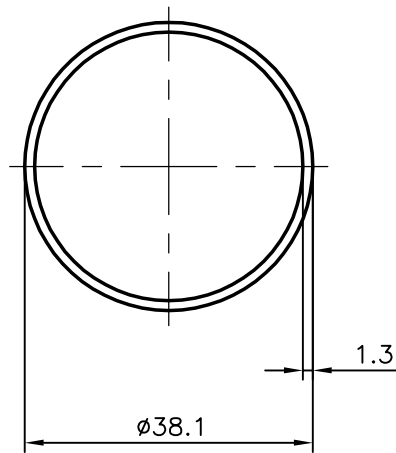

SYMBOL OF QUALITY
AN ISO 9001 COMPANY

JINDAL ALUMINIUM LTD.
BANGALORE-560073 (INDIA)

	NAME	DATE
DRAWN	PRASHANT	05-12-2006
CHECKED		
APPROVED		
SCALE		1:1
AREA mm ²		150.294
PERIMETER mm.		119.695
WEIGHT kg/m		0.405
DRAWING No.	SECTION No.	
2297	2297	
13224	13224	

1. ALL DIMENSIONS ARE IN mm.
2. ROUND OFF ALL SHARP CORNERS WITH 0.40 mm.
3. TOLERANCES WILL BE AS PER IS:2673-2002 UNLESS OTHERWISE SPECIFIED

PARTY'S NAME	GENERAL CATEGORY
PARTY'S DRAWING No.	—
ALLOY & TEMPER	HE9 WP
DESCRIPTION	ROUND TUBE