

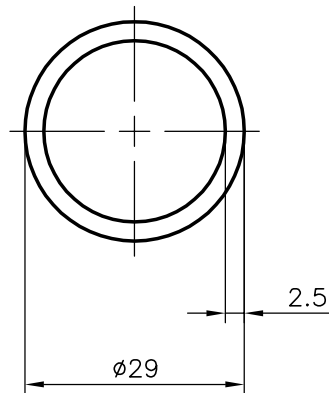

2314

13235



 SYMBOL OF QUALITY AN ISO 9001 COMPANY	JINDAL ALUMINIUM LTD. <i>BANGALORE-560073 (INDIA)</i>		NAME	DATE
		DRAWN	J.P.KAUSHIK	30-10-2006
1. ALL DIMENSIONS ARE IN mm. 2. ROUND OFF ALL SHARP CORNERS WITH 0.40 mm. 3. TOLERANCES WILL BE AS PER IS:2673-2002 UNLESS OTHERWISE SPECIFIED		CHECKED		
		APPROVED		
PARTY'S NAME —		SCALE		1:1
		AREA mm ²		208.131
PARTY'S DRAWING No. —		PERIMETER mm.		91.106
		WEIGHT kg/m		0.562
ALLOY & TEMPER HE9 WP		DRAWING No.	SECTION No.	
		2314	2314	
DESCRIPTION ROUND TUBE		13235	13235	