

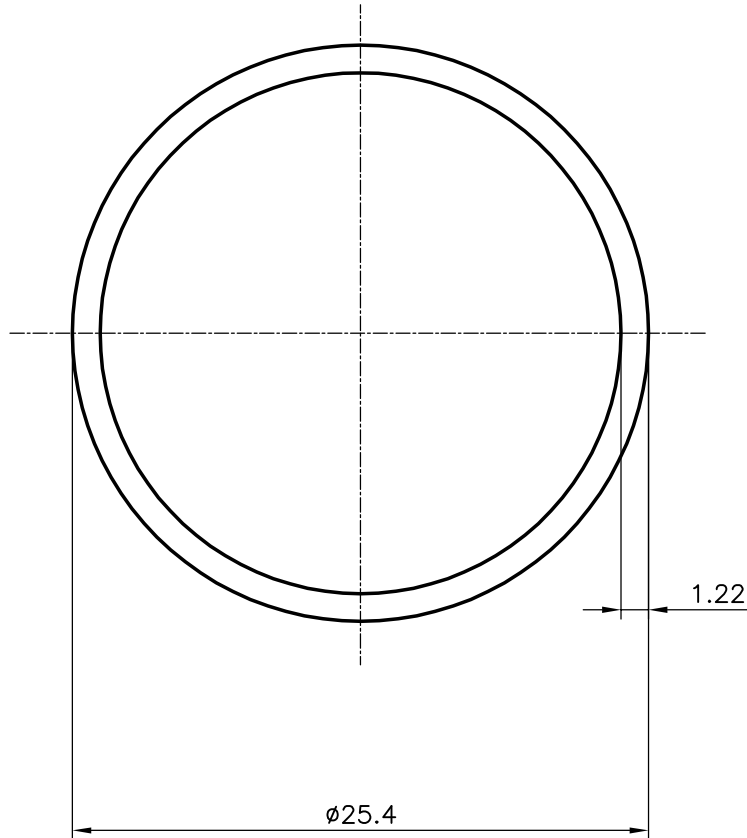

9809

13306

SCALE 1:1



NO.OF PIECES IN 100 Kgs:- 110 (AVERAGE)

 SYMBOL OF QUALITY AN ISO 9001 COMPANY	JINDAL ALUMINIUM LTD. BANGALORE-560073 (INDIA)		NAME	DATE
		DRAWN	PRASHANT	18-11-2006
1. ALL DIMENSIONS ARE IN mm. 2. ROUND OFF ALL SHARP CORNERS WITH 0.40 mm. 3. TOLERANCES WILL BE AS PER IS:2673-2002 UNLESS OTHERWISE SPECIFIED		CHECKED		
		APPROVED		
PARTY'S NAME —		SCALE	3:1	
		AREA mm ²	92.676	
PARTY'S DRAWING No. LIGHTER SECTION OF 2026		PERIMETER mm.	79.796	
		WEIGHT kg/m	0.250	
ALLOY & TEMPER HE9 WP		DRAWING No.	SECTION No.	
		9809	9809	
DESCRIPTION ROUND TUBE		13306	13306	