

PERIMETER = 94.88mm

P-3399-ISSUE 2

S718-ISSUE 2

9842

13339

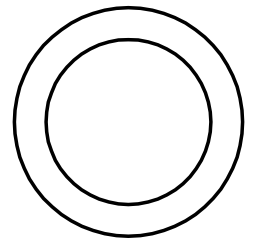

SCALE :1:1

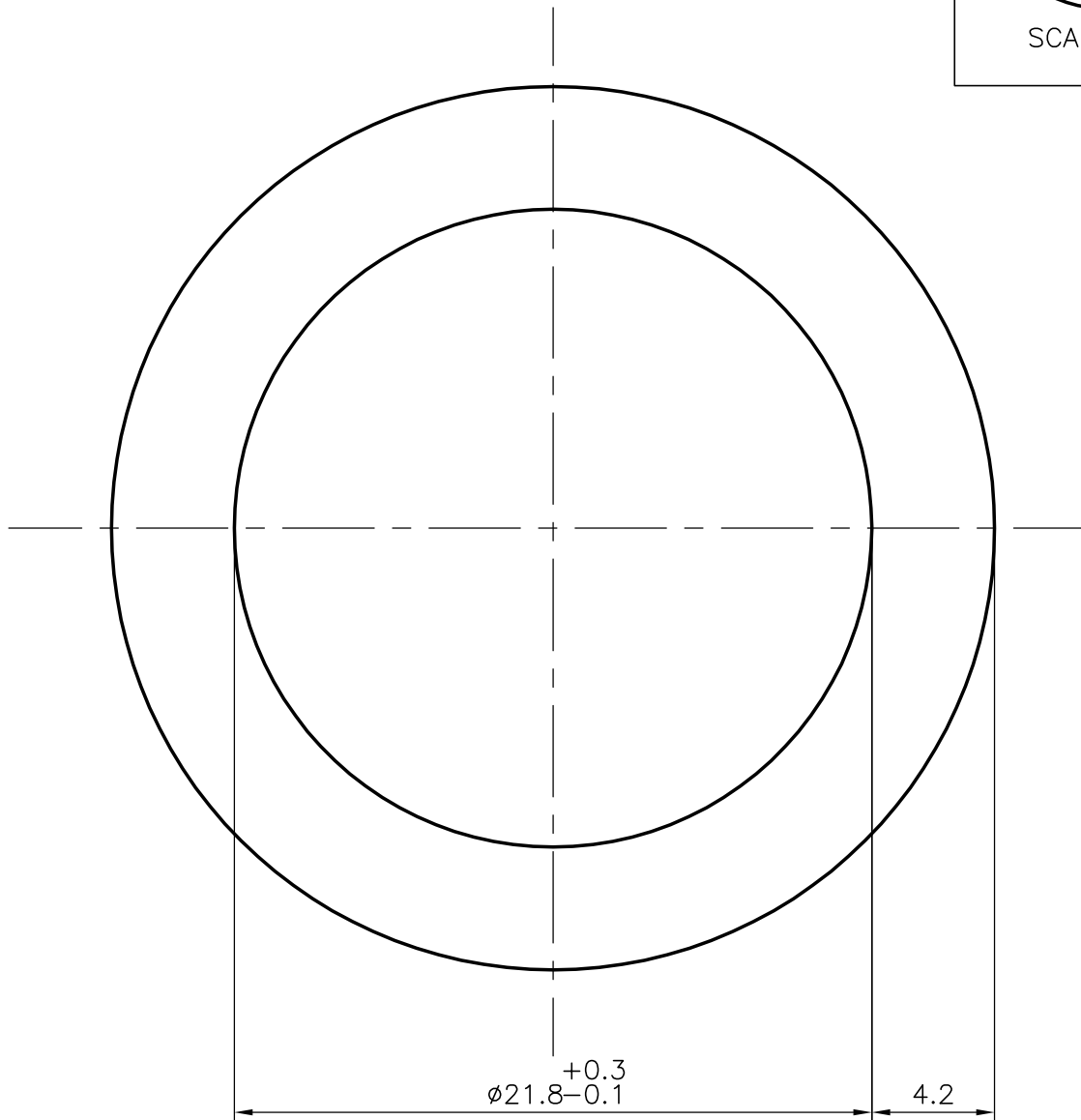

SYMBOL OF QUALITY
AN ISO 9002 COMPANY

JINDAL ALUMINIUM LTD.
BANGALORE-560073 (INDIA)

	NAME	DATE
DRAWN	SUDIP ROY	13.07.2001
CHECKED		
APPROVED		

1. ALL DIMENSIONS ARE IN mm.
2. ROUND OFF ALL SHARP CORNERS WITH 0.40 mm.
3. TOLERANCES WILL BE AS PER IS: 2673-1979 UNLESS OTHERWISE SPECIFIED

PARTY'S NAME	GRIPPERS INC .,MUMBAI	SCALE	4:1 & 1:1
PARTY'S DRAWING No.	AS PER SPECIFICATION	WEIGHT kg/m	0.926
ALLOY & TEMPER	E1E "M"	SECTION No.	13339
DESCRIPTION	ROUND TUBE	DRAWING No.	13339