

P-18693

13711

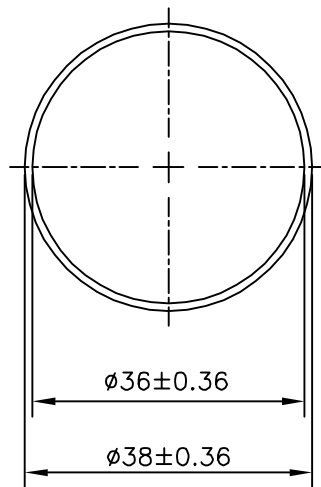

SYMBOL OF QUALITY
AN ISO 9001 COMPANY

JINDAL ALUMINIUM LTD.
BANGALORE-560073 (INDIA)

	NAME	DATE
DRAWN	J.P.KAUSHIK	18-09-2018
CHECKED		
APPROVED	B.NATARAJA	22-09-2018
SCALE		1:1
AREA mm ²		116.239
PERIMETER mm.		119.381
WEIGHT kg/m		0.314
DRAWING No.	SECTION No.	
P-18693	-	
13711	13711	

1. ALL DIMENSIONS ARE IN mm.
2. ROUND OFF ALL SHARP CORNERS WITH 0.40 mm.
3. TOLERANCES WILL BE AS PER IS:2673-2002 , UNLESS OTHERWISE SPECIFIED

PARTY'S NAME	GENERAL CATEGORY, DELHI MARKET
PARTY'S DRAWING No.	AS PER SPECIFICATION
ALLOY & TEMPER	6063 T6
DESCRIPTION	ROUND TUBE