

P-9787

15740

1:1

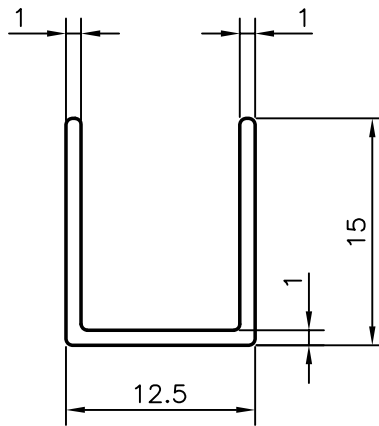

SYMBOL OF QUALITY
AN ISO 9001 COMPANY

JINDAL ALUMINIUM LTD.
BANGALORE-560073 (INDIA)

	NAME	DATE
DRAWN	J.P.KAUSHIK	05-02-2010
CHECKED		
APPROVED	S.S.GARG	03-04-2010
SCALE		2:1
AREA mm ²		40.363
PERIMETER mm.		81.627
WEIGHT kg/m		0.109

1. ALL DIMENSIONS ARE IN mm.
2. ROUND OFF ALL SHARP CORNERS WITH 0.40 mm.
3. TOLERANCES WILL BE AS PER BS:EN-755, UNLESS OTHERWISE SPECIFIED

PARTY'S NAME	DASCO DUCTING & SERVICING CO.,KUWAIT	DRAWING No.	SECTION No.
PARTY'S DRAWING No.	AS PER DRAWING	P-9787	
ALLOY & TEMPER	6063 T6	15740	15740
DESCRIPTION	CHANNEL		