

3215

16111

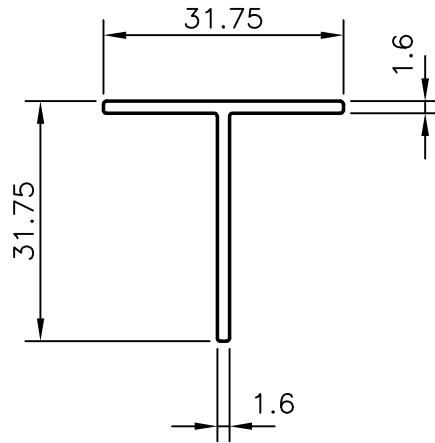

JINDAL ALUMINIUM LTD.

BANGALORE-560073

		NAME	DATE
		DRAWN	R.D.Sharma
1. ALL DIMENSIONS ARE IN mm. 2. ROUND OFF ALL SHARP CORNERS WITH 0.4 mm. 3. TOLERANCES WILL BE AS PER IS: 3965-1981 ,UNLESS OTHERWISE SPECIFIED		CHECKED	
		APPROVED	
PARTY'S NAME	—	SCALE	1:1
PARTY'S DRAWING No.	—	WEIGHT kg/m	0.267
ALLOY & TEMPER	HE9 WP	SECTION No.	16111
LENGTH	3658 mm.	DRAWING No.	
DESCRIPTION	TEE-SQUARE FILLET	16111	