

4013

18008

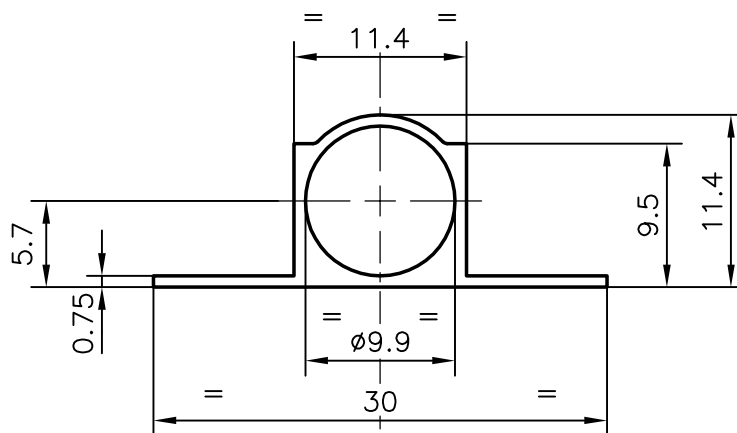

1:1



**JINDAL ALUMINIUM LTD.**

**BANGALORE-560073**

NAME

DATE

DRAWN

R.D.Sharma

16-04-97

1. ALL DIMENSIONS ARE IN mm.
2. ROUND OFF ALL SHARP CORNERS WITH 0.4 mm.
3. TOLERANCES WILL BE AS PER IS: 6477-1983 ,UNLESS OTHERWISE SPECIFIED

CHECKED

APPROVED

PARTY'S NAME

-

SCALE

2:1

PARTY'S DRAWING No.

-

WEIGHT kg/m

0.156

ALLOY &amp; TEMPER

HE9 WP

SECTION No.

18008

LENGTH

3658 mm.

DRAWING No.

DESCRIPTION

TOWER BOLT

18008