

4017

18009

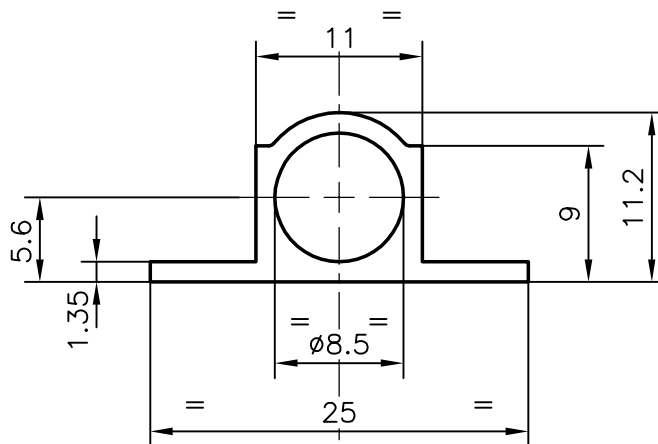

1:1



3658 mm. LONG PIECES IN 100 kgs. :- 135 PIECES (AVERAGE)

JINDAL ALUMINIUM LTD.

BANGALORE-560073

NAME

DATE

DRAWN

R.D.Sharma

22-04-97

1. ALL DIMENSIONS ARE IN mm.
2. ROUND OFF ALL SHARP CORNERS WITH 0.4 mm.
3. TOLERANCES WILL BE AS PER IS: 6477-1983 ,UNLESS OTHERWISE SPECIFIED

CHECKED

APPROVED

PARTY'S NAME

-

SCALE

2:1

PARTY'S DRAWING No.

-

WEIGHT kg/m

0.202

ALLOY & TEMPER

HE9 WP

SECTION No.

18009

LENGTH

3658 mm.

DRAWING No.

DESCRIPTION

TOWER BOLT

18009