

4032

18401

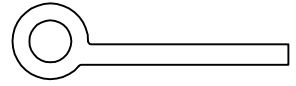

1:1

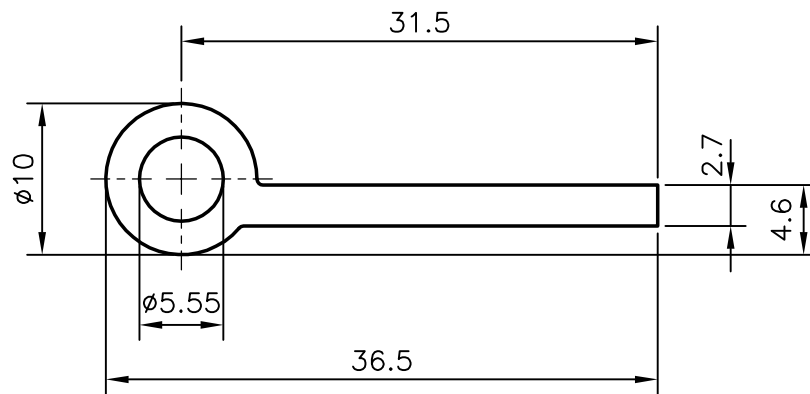

JINDAL ALUMINIUM LTD.

BANGALORE-560073

NAME

DATE

DRAWN

R.D.Sharma

25-11-97

CHECKED

APPROVED

1. ALL DIMENSIONS ARE IN mm.
2. ROUND OFF ALL SHARP CORNERS WITH 0.4 mm.
3. TOLERANCES WILL BE AS PER IS: 6477-1983 ,UNLESS OTHERWISE SPECIFIED

PARTY'S NAME

GENERAL CATEGORY

SCALE

2:1

PARTY'S DRAWING No.

-

WEIGHT kg/m

0.343

ALLOY & TEMPER

HE9 WP

SECTION No.

18401

LENGTH

3658 mm.

DRAWING No.

DESCRIPTION

HOLLOW HINGE-SPECIAL

18401