

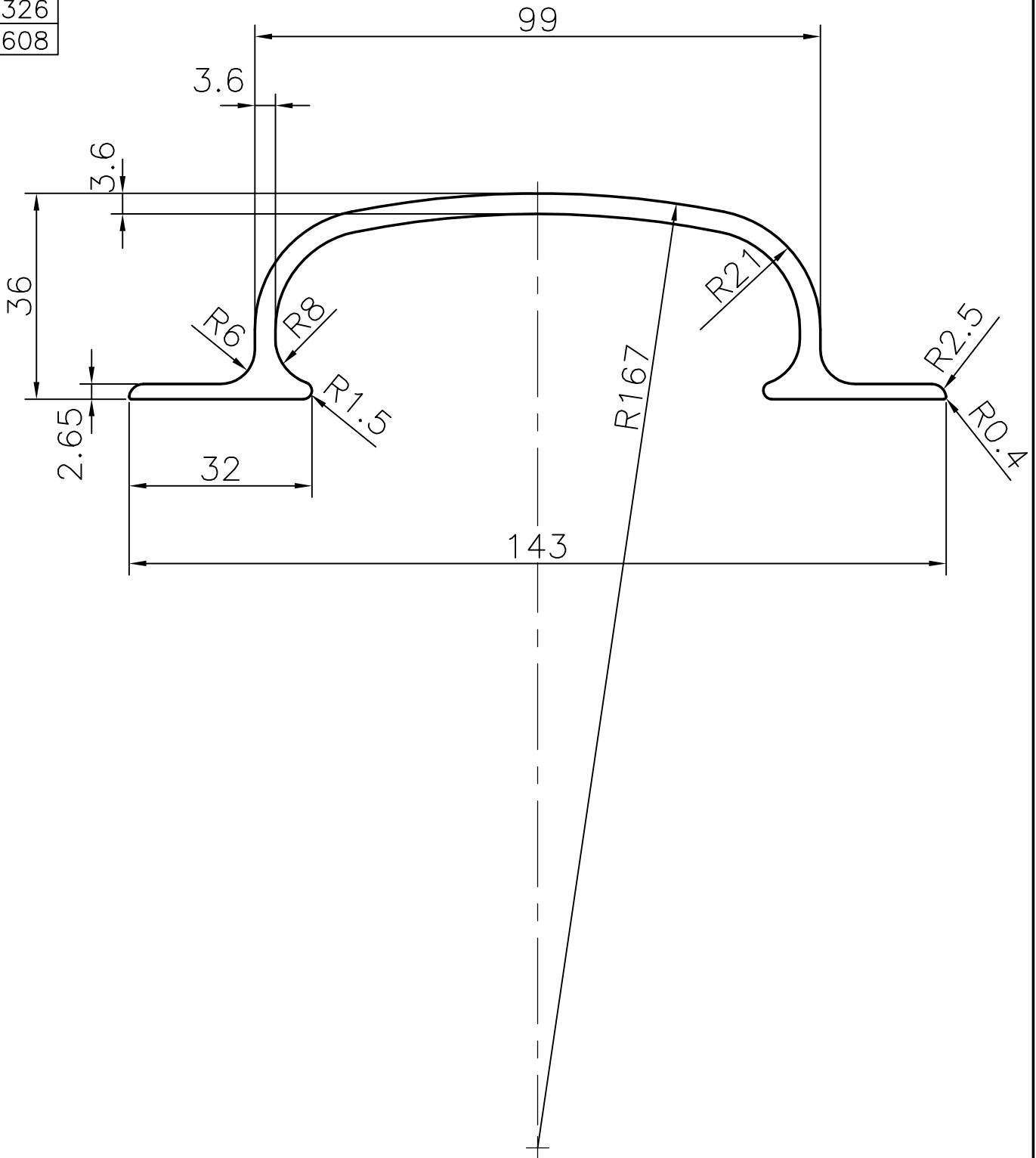

6654  
14326  
18608



WEIGHT PER PIECE (12') :- 6.900 kg (AVERAGE)

 SYMBOL OF QUALITY AN ISO 9002 COMPANY	<b>JINDAL ALUMINIUM LTD.</b> BANGALORE-560073 (INDIA)	NAME	DATE
		DRAWN	R.D.Sharma 13-09-2000
1. ALL DIMENSIONS ARE IN mm. 2. ROUND OFF ALL SHARP CORNERS WITH 0.40 mm. 3. TOLERANCES WILL BE AS PER IS 3965-1981 UNLESS OTHERWISE SPECIFIED		CHECKED	
		APPROVED	
		SCALE	1:1
PARTY'S NAME	GENERAL CATEGORY (DELHI MARKET)	WEIGHT kg/m	1.885
PARTY'S DRAWING No.	NIL	SECTION No.	18608
ALLOY & TEMPER	HE9 WP	DRAWING No.	
DESCRIPTION	HANDLE SECTION	18608	