

P-4202

14355

18613

WEIGHT PER PIECE (12') :- 6.200-6.400 kg

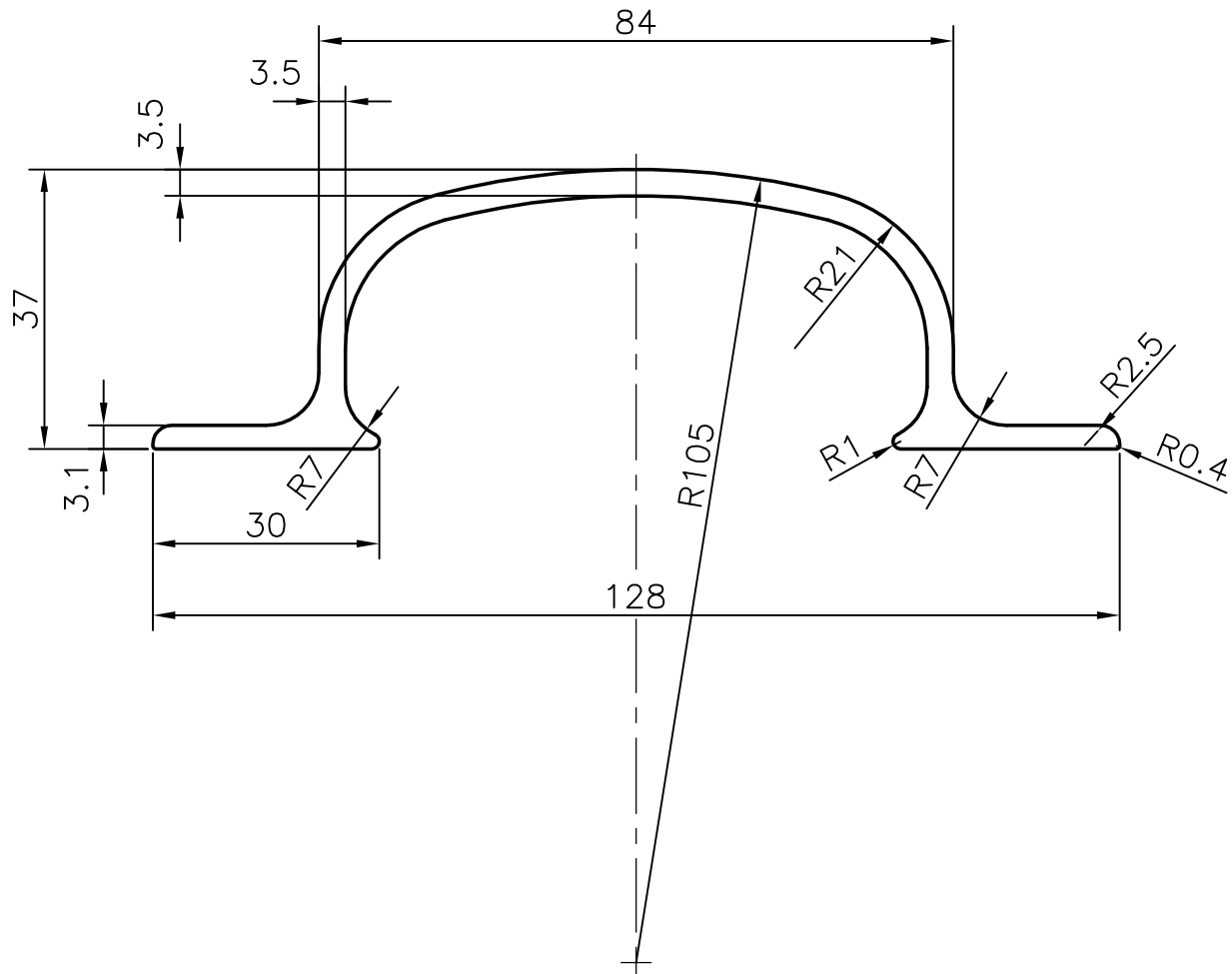

SYMBOL OF QUALITY
AN ISO 9002 COMPANY

JINDAL ALUMINIUM LTD.
BANGALORE-560073 (INDIA)

	NAME	DATE
DRAWN	R.D.Sharma	25-04-2003
CHECKED		
APPROVED		

1. ALL DIMENSIONS ARE IN mm.
2. ROUND OFF ALL SHARP CORNERS WITH 0.40 mm.
3. TOLERANCES WILL BE AS PER IS 3965-1981 UNLESS OTHERWISE SPECIFIED

SCALE	1:1
AREA mm ²	638.7
PERIMETER mm.	357.3
WEIGHT kg/m	1.724

PARTY'S NAME	GENERAL CATEGORY, DELHI MARKET
PARTY'S DRAWING No.	AS PER SAMPLE
ALLOY & TEMPER	HE9 WP
DESCRIPTION	'C' HANDLE SECTION

DRAWING No.	SECTION No.
P-4202	-
14355	14355
18613	18613