

P-18493

18649

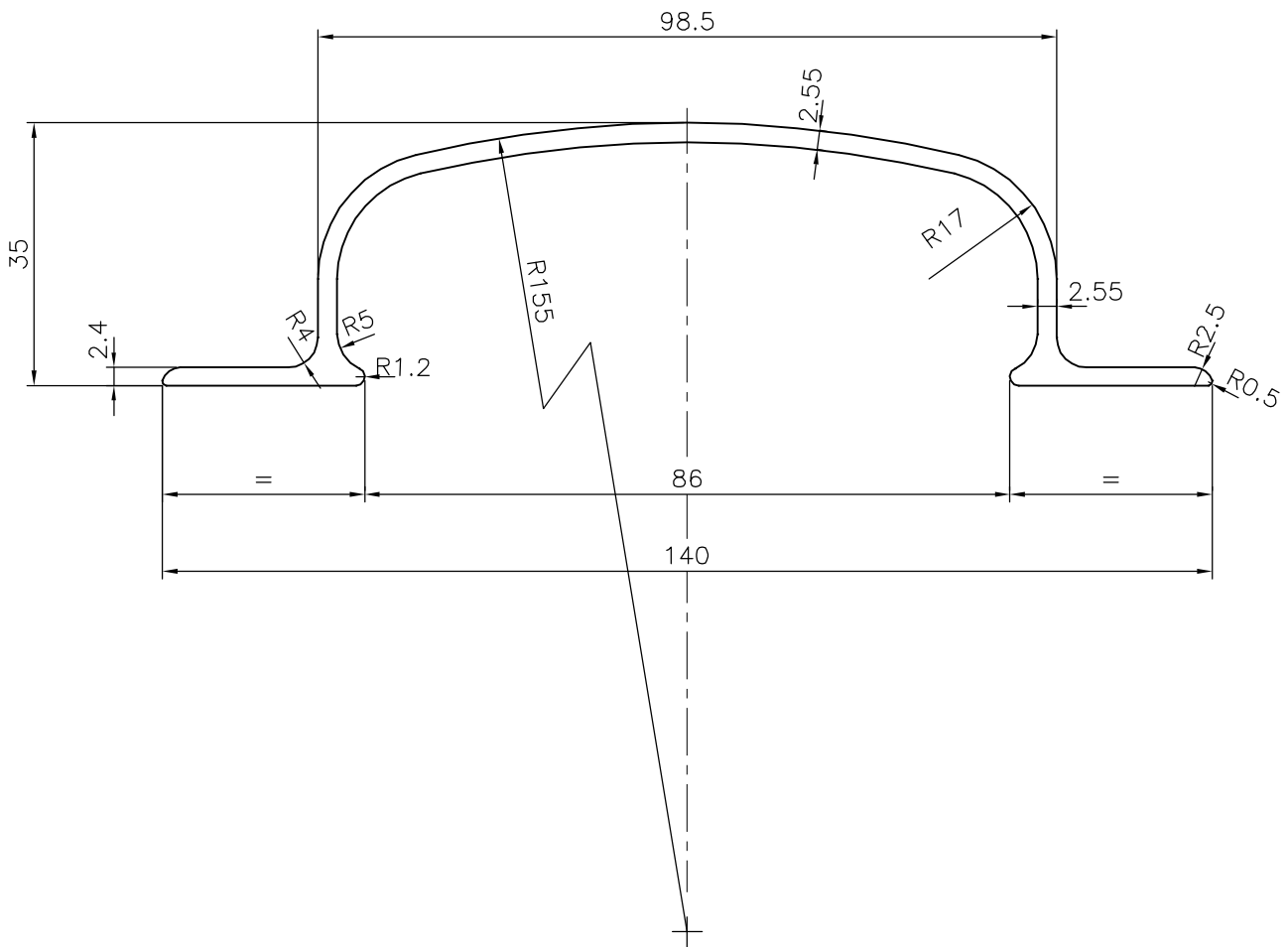

SYMBOL OF QUALITY
AN ISO 9001 COMPANY

JINDAL ALUMINIUM LTD.
BANGALORE-560073 (INDIA)

	NAME	DATE
DRAWN	J.P.KAUSHIK	28-07-2018
CHECKED		
APPROVED	B.NATARAJA	16-11-2018

1. ALL DIMENSIONS ARE IN mm.
2. ROUND OFF ALL SHARP CORNERS WITH 0.40 mm.
3. TOLERANCES WILL BE AS PER IS:3965-1981 UNLESS OTHERWISE SPECIFIED

SCALE	1:1
AREA mm ²	491.935
PERIMETER mm.	377.333
WEIGHT kg/m	1.328

PARTY'S NAME	GENERAL CATEGORY, DELHI MARKET
PARTY'S DRAWING No.	AS PER DRAWING
ALLOY & TEMPER	HE9 WP A3D
DESCRIPTION	HANDALE SECTION

DRAWING No.	SECTION No.
P-18493	
18649	18649