

P-19745

18668

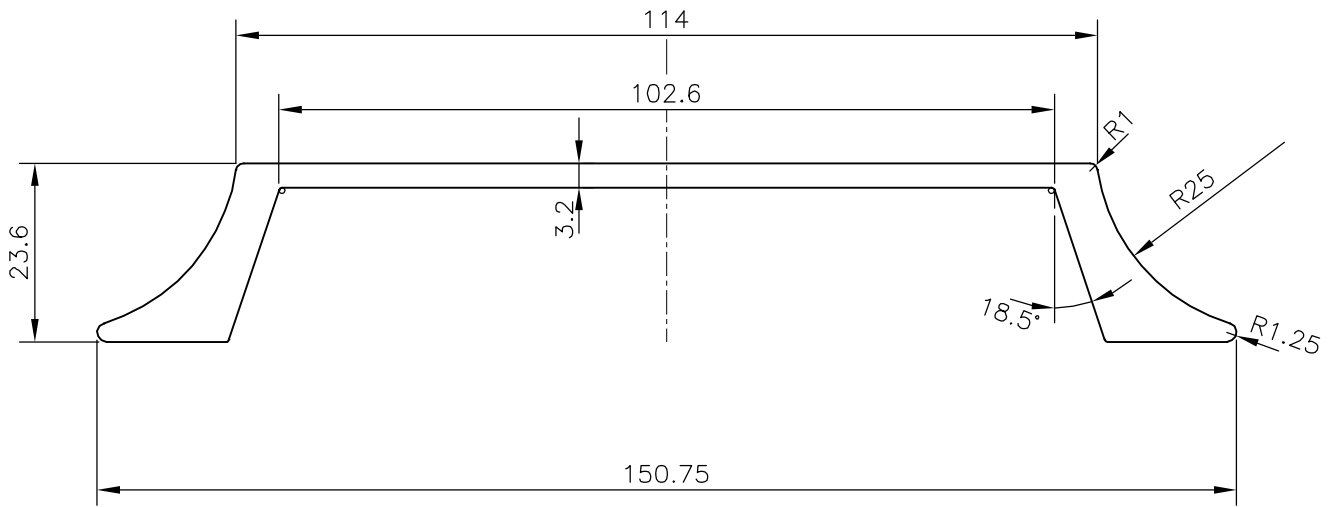

SYMBOL OF QUALITY
AN ISO 9001 COMPANY

JINDAL ALUMINIUM LTD.
BANGALORE-560073 (INDIA)

	NAME	DATE
DRAWN	J.P.KAUSHIK	02-07-2019
CHECKED		
APPROVED	J.N. RAI	13-07-2019
SCALE		1:1
AREA mm ²		764.213
PERIMETER mm.		355.853
WEIGHT kg/m		2.063
DRAWING No.	SECTION No.	
P-19745	-	
18668	18668	

1. ALL DIMENSIONS ARE IN mm.
2. ROUND OFF ALL SHARP CORNERS WITH 0.40 mm.
3. TOLERANCES WILL BE AS PER IS:3965-1981 , UNLESS OTHERWISE SPECIFIED

PARTY'S NAME	GENERAL CATEGORY, DELHI MARKET
PARTY'S DRAWING No.	AS PER SAMPLE
ALLOY & TEMPER	HE9 WP
DESCRIPTION	HANDLE SECTION