

4653

11041

20026

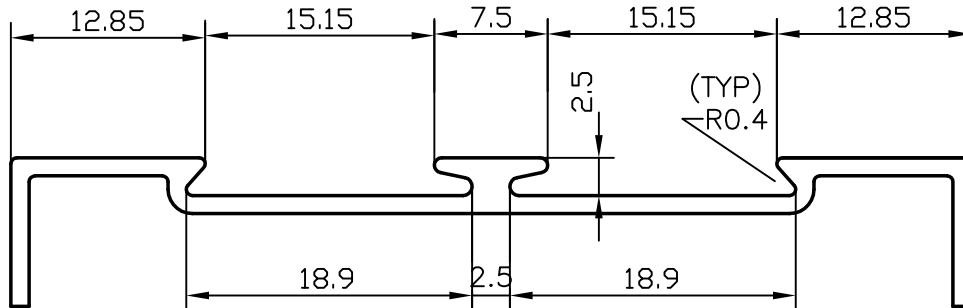

A (2:1)

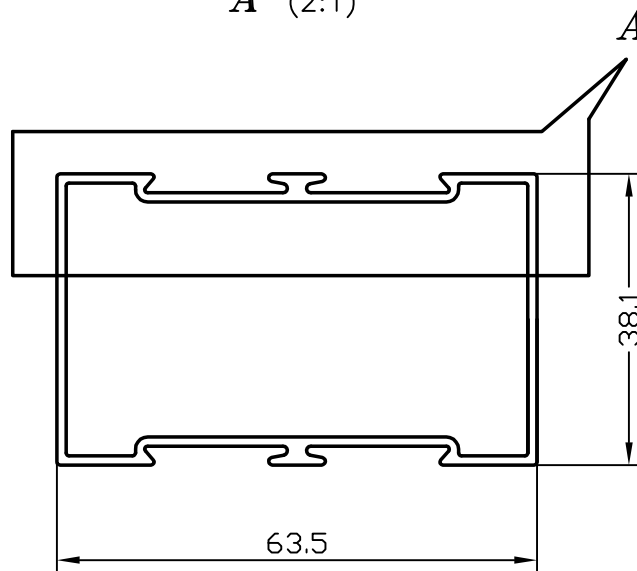

1. GENERAL WALL THICKNESS :- 1.21mm.
2. 3658 mm. LONG PIECES IN 100 kgs :- 36 (AVERAGE)



SYMBOL OF QUALITY
AN ISO 9001 COMPANY

JINDAL ALUMINIUM LTD.
BANGALORE-560073 (INDIA)

	NAME	DATE
DRAWN	D.K Shaw	20-10-03
CHECKED		
APPROVED		

1. ALL DIMENSIONS ARE IN mm.
2. ROUND OFF ALL SHARP CORNERS WITH 0.40 mm.
3. TOLERANCES WILL BE AS PER IS: 6477-1983 UNLESS OTHERWISE SPECIFIED

SCALE	1:1
AREA mm ²	281.5
PERIMETER mm.	242.84
WEIGHT kg/m	0.761

PARTY'S NAME	GENERAL CATEGORY
PARTY'S DRAWING No.	-
ALLOY & TEMPER	HE9 WP
DESCRIPTION	PARTITION SECTION

DRAWING No.	SECTION No.
4653	4653
11041	11041
20026	20026