

4684

11014

20044

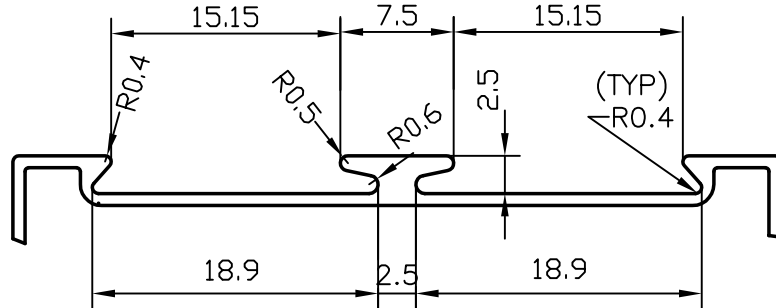

A (2:1)

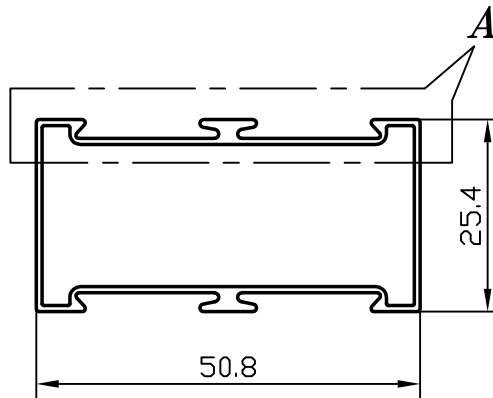

1. GENERAL WALL THICKNESS :- 0.79 mm.
2. 3658 mm. LONG PIECES IN 100 kgs :- 66 (AVERAGE)



SYMBOL OF QUALITY
AN ISO 9001 COMPANY

JINDAL ALUMINIUM LTD.
BANGALORE-560073 (INDIA)

	NAME	DATE
DRAWN	D.K Shaw	22-10-03
CHECKED		
APPROVED		

1. ALL DIMENSIONS ARE IN mm.
2. ROUND OFF ALL SHARP CORNERS WITH 0.40 mm.
3. TOLERANCES WILL BE AS PER IS: 6477-1983 UNLESS OTHERWISE SPECIFIED

SCALE	1:1
AREA mm ²	154.6
PERIMETER mm.	192.01
WEIGHT kg/m	0.414

PARTY'S NAME	GENERAL CATEGORY	DRAWING No.	SECTION No.
PARTY'S DRAWING No.	-	4684	4684
ALLOY & TEMPER	HE9 WP	11014	11014
		20044	20044
DESCRIPTION	PARTITION SECTION		