

4686

11045

20046

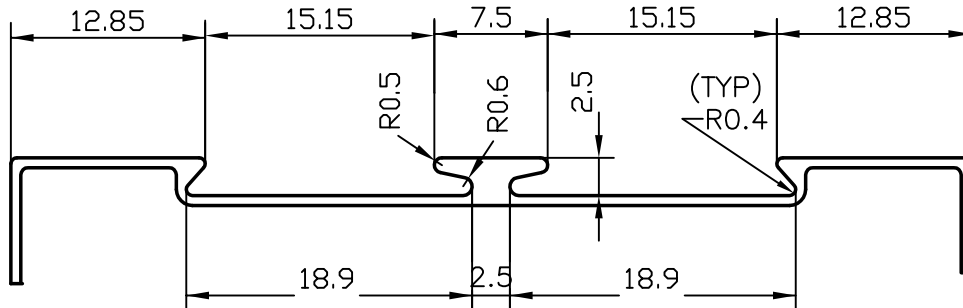

A (2:1)

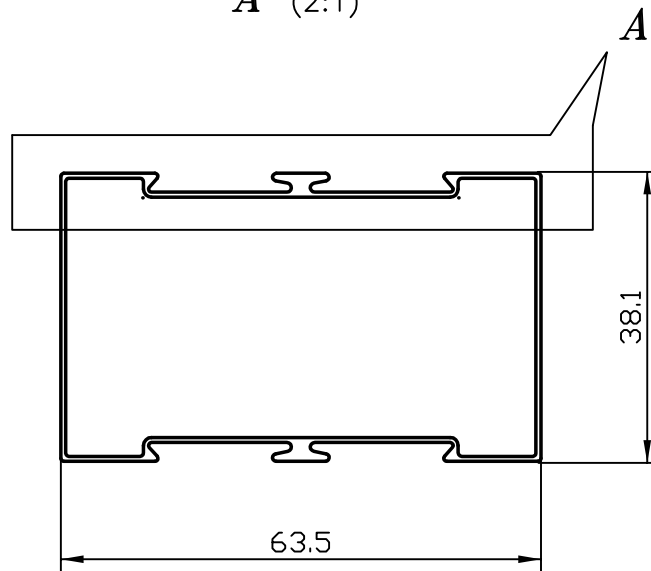

1. GENERAL WALL THICKNESS :- 0.66 mm.
2. 3658 mm. LONG PIECES IN 100 kgs :- 60 (AVERAGE)



SYMBOL OF QUALITY
AN ISO 9001 COMPANY

JINDAL ALUMINIUM LTD.
BANGALORE-560073 (INDIA)

	NAME	DATE
DRAWN	D.K Shaw	20-10-03
CHECKED		
APPROVED		

1. ALL DIMENSIONS ARE IN mm.
2. ROUND OFF ALL SHARP CORNERS WITH 0.40 mm.
3. TOLERANCES WILL BE AS PER IS: 6477-1983 UNLESS OTHERWISE SPECIFIED

SCALE	1:1
AREA mm ²	169.6
PERIMETER mm.	242.81
WEIGHT kg/m	0.455

PARTY'S NAME	GENERAL CATEGORY	DRAWING No.	SECTION No.
PARTY'S DRAWING No.	-	4686	4686
ALLOY & TEMPER	HE9 WP	11045	11045
		20046	20046
DESCRIPTION	PARTITION SECTION		