

P-13434

22574

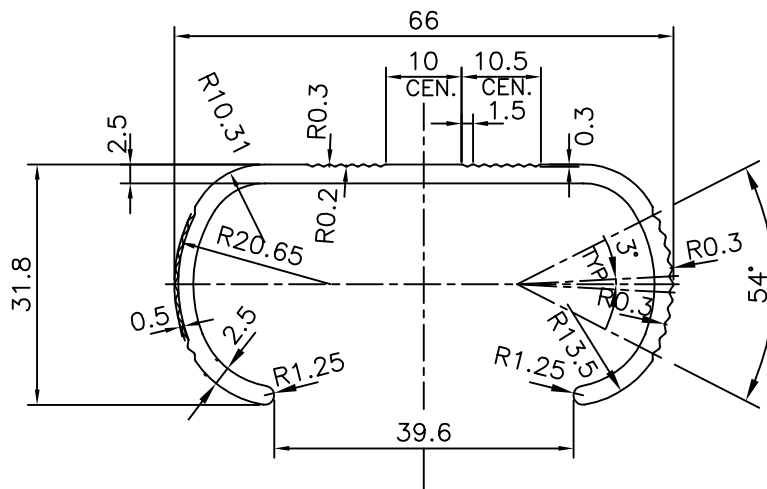

TOLERANCES ON OVERALL WIDTHS & WIDTHS ACROSS FLATS OF BARS, & REGULAR SECTIONS

UPTO 6.40mm - ±0.20	UPTO 32.0mm - ±0.38	UPTO 120.0mm - ±0.85	UPTO 320.00mm - ±1.70
UPTO 10.0mm - ±0.23	UPTO 50.0mm - ±0.46	UPTO 160.0mm - ±1.02	
UPTO 12.0mm - ±0.25	UPTO 60.0mm - ±0.53	UPTO 200.0mm - ±1.14	
UPTO 16.0mm - ±0.28	UPTO 80.0mm - ±0.69	UPTO 250.0mm - ±1.40	
UPTO 25.0mm - ±0.30	UPTO 100.0mm - ±0.75	UPTO 300.0mm - ±1.65	



SYMBOL OF QUALITY
AN ISO 9001 COMPANY

JINDAL ALUMINIUM LTD.
BANGALORE-560073 (INDIA)

	NAME	DATE
DRAWN	J.P.KAUSHIK	28-02-2014
CHECKED		
APPROVED	J.N. RAI	11-03-2014

1. ALL DIMENSIONS ARE IN mm.
2. ROUND OFF ALL SHARP CORNERS WITH 0.40 mm.
3. TOLERANCES WILL BE AS PER IS:3965-1981, UNLESS OTHERWISE SPECIFIED

SCALE	1:1
AREA mm ²	296.332
PERIMETER mm.	257.991
WEIGHT kg/m	0.800

PARTY'S NAME	GENERAL CATEGORY , MUMBAI MARKET
PARTY'S DRAWING No.	AS PER DRAWING
ALLOY & TEMPER	HE9 WP
DESCRIPTION	LADDER SECTION

DRAWING No.	SECTION No.
P-13434	-
22574	22574