

P-14628

26896

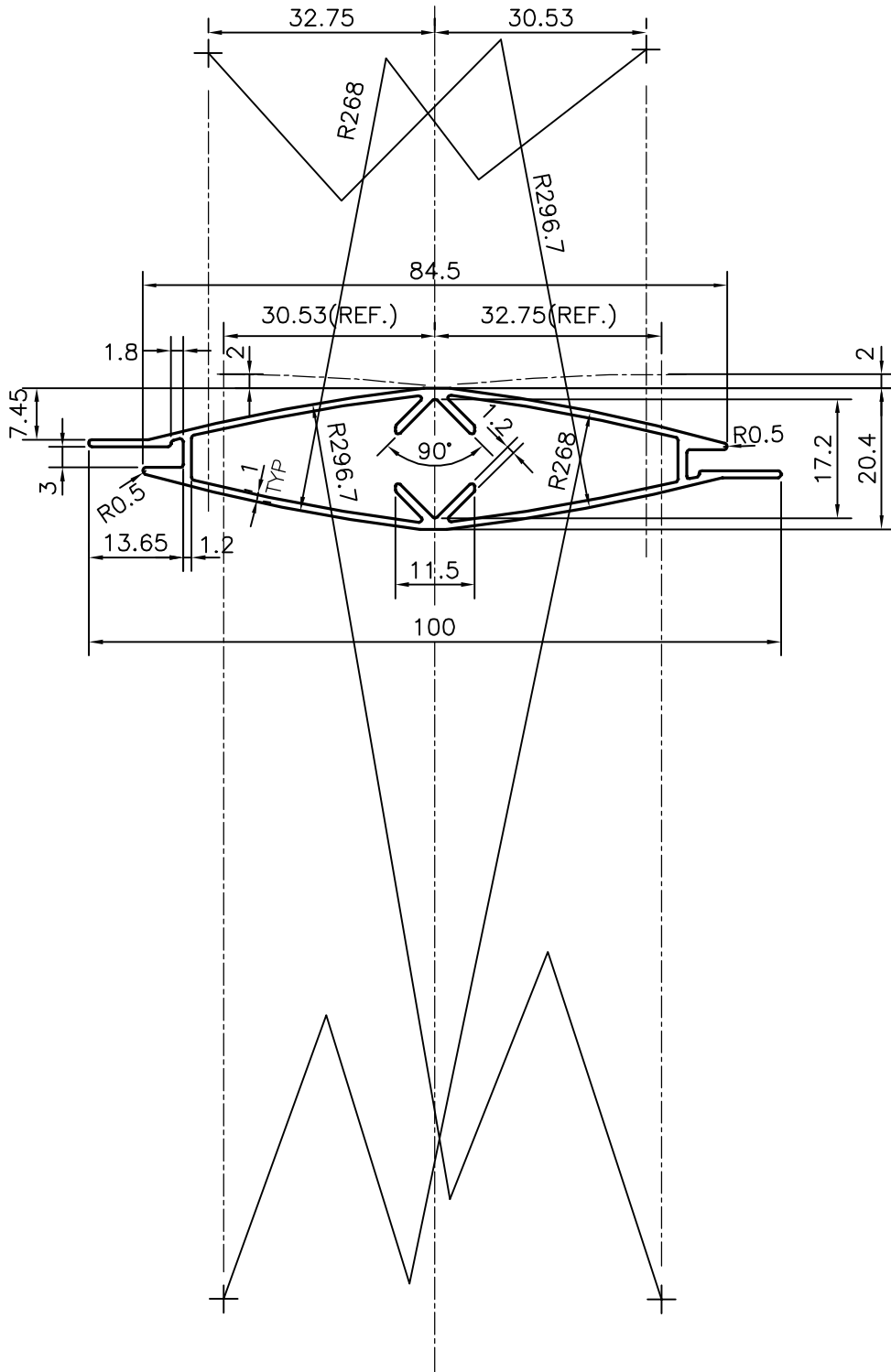

SYMBOL OF QUALITY
AN ISO 9001 COMPANY

JINDAL ALUMINIUM LTD.
BANGALORE-560073 (INDIA)

	NAME	DATE
DRAWN	J.P.KAUSHIK	07-05-2015
CHECKED		
APPROVED	S.S.GARG	01-06-2015
SCALE		1:1
AREA mm ²		248.416
PERIMETER mm.		237.97
WEIGHT kg/m		0.671
DRAWING No.	SECTION No.	
P-14628	-	
26896	26896	

1. ALL DIMENSIONS ARE IN mm.
2. ROUND OFF ALL SHARP CORNERS WITH 0.40 mm.
3. TOLERANCES WILL BE AS PER,BS:EN-755-9 UNLESS OTHERWISE SPECIFIED

PARTY'S NAME	KBE INTERNATIONAL SAL LEBANON,MIDDLE EAST
PARTY'S DRAWING No.	AS PER DRAWING
ALLOY & TEMPER	6063 T6
DESCRIPTION	MISC. SECTION