

P-16496-1

S5167

28413

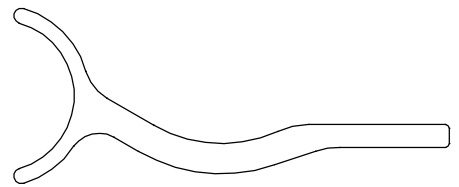

SCALE 1:1

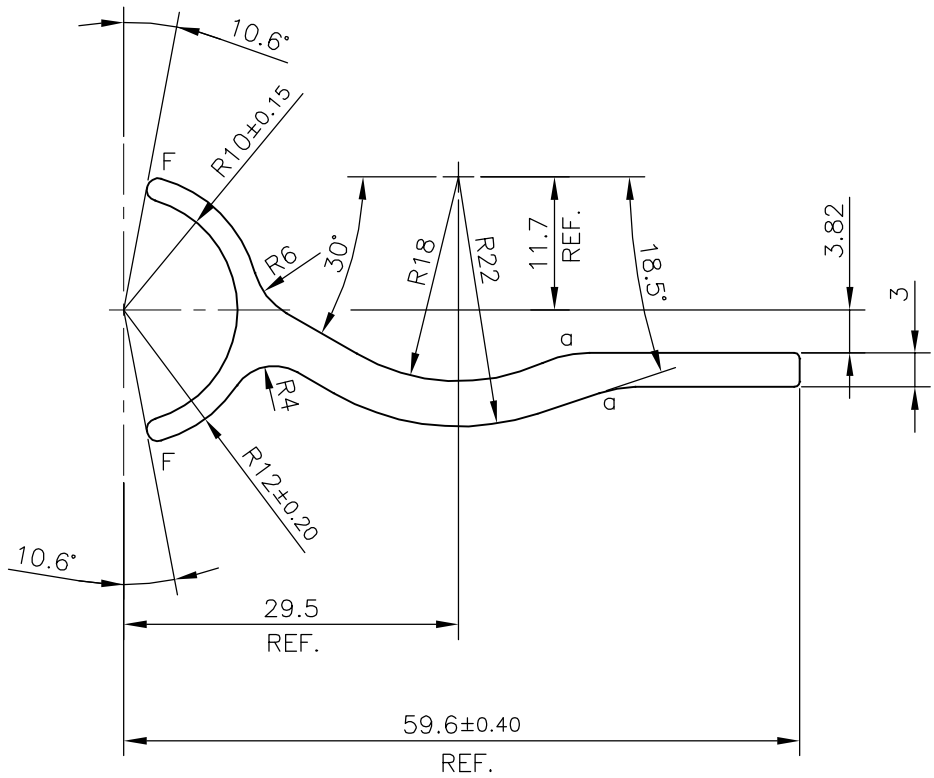

a : RADIUS 10.00 mm (2 PLACES)

F : FULL RADIUS (2 PLACES)

TOLERANCES ON OVERALL WIDTHS & WIDTHS ACROSS FLATS OF BARS, & REGULAR SECTIONS

UPTO 6.40mm - ±0.20	UPTO 32.0mm - ±0.38	UPTO 120.0mm - ±0.85	1. STRAIGHTNESS=1.7mm/M 2. TWIST=1.7mm/M 3. ANGULARITY= ±2° 4. FLATNESS =0.007xWIDTH
UPTO 10.0mm - ±0.23	UPTO 50.0mm - ±0.46	UPTO 160.0mm - ±1.02	
UPTO 12.0mm - ±0.25	UPTO 60.0mm - ±0.53	UPTO 200.0mm - ±1.14	
UPTO 16.0mm - ±0.28	UPTO 80.0mm - ±0.69	UPTO 250.0mm - ±1.40	
UPTO 25.0mm - ±0.30	UPTO 100.0mm - ±0.75	UPTO 300.0mm - ±1.65	



SYMBOL OF QUALITY
AN ISO 9001 COMPANY

JINDAL ALUMINIUM LTD.
BANGALORE-560073 (INDIA)

	NAME	DATE
DRAWN	KIRAN	05-11-2016
CHECKED		
APPROVED	B.NATARAJ	11-11-2016

1. ALL DIMENSIONS ARE IN mm.
2. ROUND OFF ALL SHARP CORNERS WITH 0.50 mm.
3. TOLERANCES WILL BE AS PER IS:3965-1981, UNLESS OTHERWISE SPECIFIED

SCALE	1.5:1
AREA mm ²	246.3
PERIMETER mm.	158.891
WEIGHT kg/m	0.665

PARTY'S NAME	WONJIN AUTOPARTS INDIA PVT. LTD., CHENNAI
PARTY'S DRAWING No.	HC844A1V1A-01
ALLOY & TEMPER	6005 T5
DESCRIPTION	BRACKET SECTION

DRAWING No.	SECTION No.
P-16496-1	
S5167	S5167
28413	28413