

P-16282-1

S5076

29676

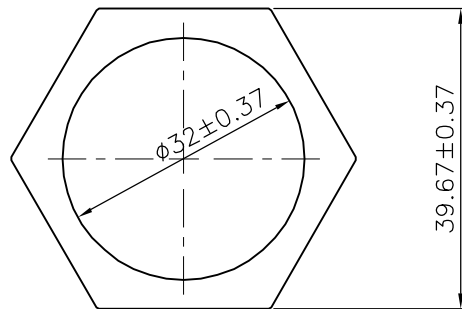

SYMBOL OF QUALITY
AN ISO 9001 COMPANY

JINDAL ALUMINIUM LTD.
BANGALORE-560073 (INDIA)

	NAME	DATE
DRAWN	J.P.KAUSHIK	01-09-2016
CHECKED		
APPROVED	S.S. GARG	03-09-2016
SCALE		1:1
AREA mm ²		558.573
PERIMETER mm.		137.163
WEIGHT kg/m		1.508
DRAWING No.	SECTION No.	
P-16282-1	-	
S5076	S5076	
29676	29676	

1. ALL DIMENSIONS ARE IN mm.
2. ROUND OFF ALL SHARP CORNERS WITH 0.40 mm.
3. TOLERANCES WILL BE AS PER IS:6477-1983 UNLESS OTHERWISE SPECIFIED

PARTY'S NAME	VMX CONNECTORS PVT. LTD., BANGALORE
PARTY'S DRAWING No.	AS PER SPECIFICATION
ALLOY & TEMPER	6061 T6
DESCRIPTION	HEXAGONAL TUBE