

P-10450-1

35035

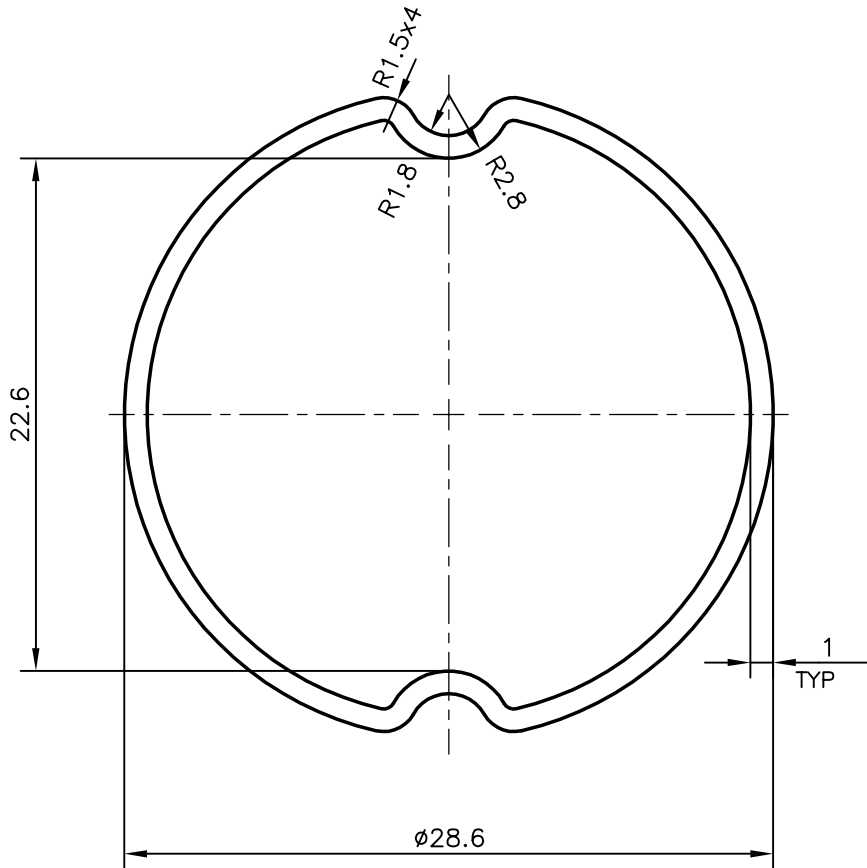
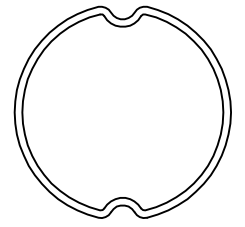

SYMBOL OF QUALITY
AN ISO 9001 COMPANY

JINDAL ALUMINIUM LTD.
BANGALORE-560073 (INDIA)

	NAME	DATE
DRAWN	J.P.KAUSHIK	02-11-2010
CHECKED		
APPROVED	S.S.GARG	13-11-2010
SCALE		3:1
AREA mm ²		89.017
PERIMETER mm.		92.198
WEIGHT kg/m		0.24
DRAWING No.	SECTION No.	
P-10450-1	-	
35035	35035	

1. ALL DIMENSIONS ARE IN mm.
2. ROUND OFF ALL SHARP CORNERS WITH 0.50 mm.
3. TOLERANCES WILL BE AS PER IS:6477-1983 UNLESS OTHERWISE SPECIFIED

PARTY'S NAME	GENERAL CATEGORY, DELHI MARKET
PARTY'S DRAWING No.	AS PER DRAWING
ALLOY & TEMPER	6063 T6
DESCRIPTION	MISC. TUBE