

P-9971-1

35057

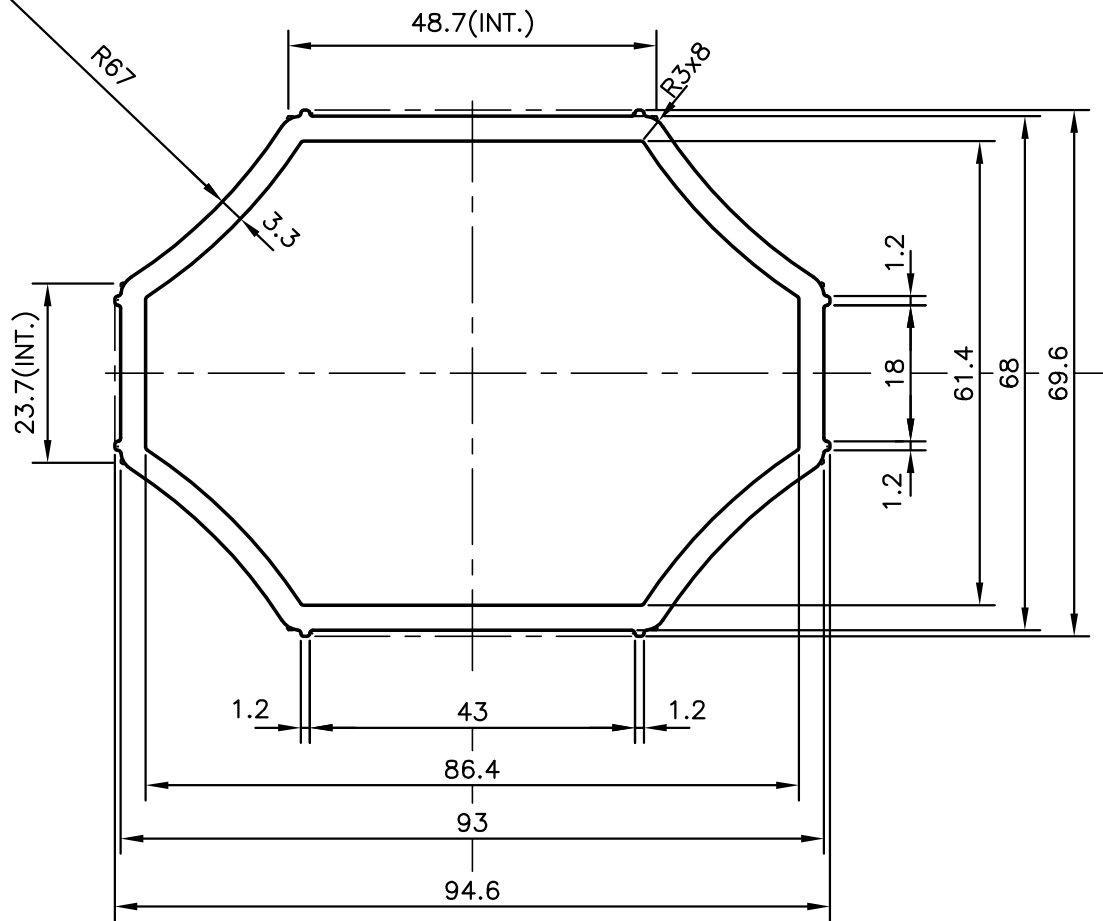

SYMBOL OF QUALITY
AN ISO 9001 COMPANY

JINDAL ALUMINIUM LTD.
BANGALORE-560073 (INDIA)

	NAME	DATE
DRAWN	J.P.KAUSHIK	07-09-2012
CHECKED		
APPROVED	S.S.GARG	13-10-2012
SCALE		1:1
AREA mm ²		861.081
PERIMETER mm.		276.474
WEIGHT kg/m		2.325
DRAWING No.	SECTION No.	
P-9971-1	-	
35057	35057	

1. ALL DIMENSIONS ARE IN mm.
2. ROUND OFF ALL SHARP CORNERS WITH 0.40 mm.
3. TOLERANCES WILL BE AS PER IS:6477-1983 UNLESS OTHERWISE SPECIFIED

PARTY'S NAME	GENERAL CATEGORY, DELHI MARKET
PARTY'S DRAWING No.	AS PER DRAWING
ALLOY & TEMPER	HE9 WP
DESCRIPTION	MISC. TUBE