

P-12169

E0066

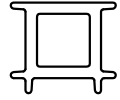

SCALE:- 1:1

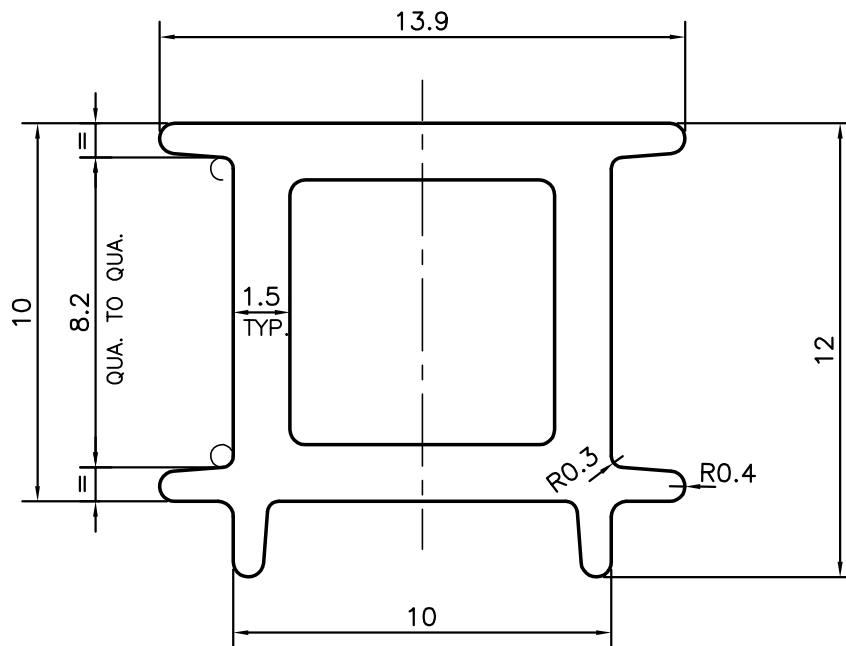

SYMBOL OF QUALITY
AN ISO 9001 COMPANY

JINDAL ALUMINIUM LTD.
BANGALORE-560073 (INDIA)

	NAME	DATE
DRAWN	PARVESH	22-10-2012
CHECKED		
APPROVED	S.S.GARG	12-11-2012
SCALE		5:1
AREA mm ²		60.911
PERIMETER mm.		59.847
WEIGHT kg/m		0.164
DRAWING No.	SECTION No.	
P-12169	-	
E0066	E0066	

1. ALL DIMENSIONS ARE IN mm.
2. ROUND OFF ALL SHARP CORNERS WITH 0.40 mm.
3. TOLERANCES WILL BE AS PER IS:6477-1983, UNLESS OTHERWISE SPECIFIED

PARTY'S NAME	SURFACES, BANGALORE
PARTY'S DRAWING No.	SAMPLE No.-10
ALLOY & TEMPER	HE9 WP
DESCRIPTION	ARCHITECTURAL SECTION